

ЛІТЕРАТУРА

**Міністерство освіти і науки України  
Тернопільський національний технічний університет  
імені Івана Пулюя**

Кафедра будівельної механіки



НАВЧАЛЬНО-МЕТОДИЧНА

**Методичні вказівки  
до виконання лабораторних робіт  
з курсу «Програмне забезпечення інженерних  
розрахунків»**

для студентів спеціальності  
192 «Будівництво та цивільна інженерія»

Тернопіль  
2022

**Ministry of Education and Science of Ukraine  
Ternopil Ivan Puluj National Technical University**

Department of Structural Mechanics



**Methodical instructions  
for laboratory works  
on the course «Software for Engineering Design»**

for students of all forms of study  
of speciality 192 «Construction and Civil Engineering»

Ternopil  
2022

УНІВЕРСИТЕТ

НАВЧАЛЬНО-МЕТОДИЧНА

UDC 69.04  
M54

**Compiler:**

Andrii Soroachak, Ph.D., Assoc. Prof. of the Department of Structural Mechanics

**Reviewer:**

Ihor Okipnyi, Ph.D., Assoc. Prof., Head of the Department of Engineering of  
Machine-building Technologies

Recommended for publishing by the scientific and methodical council of the Faculty  
of Engineering of Machines, Structures and Technologies of the TNTU.  
Minutes No. 3 from October «21», 2022.

M54 Methodical instructions for laboratory works on the course «Software for  
Engineering Design» for students of all forms of study of speciality  
192 «Construction and Civil Engineering»/ Soroachak A.–Ternopil: TNTU,  
2022.–52 p.

Examples of modelling of linear, nonlinear and super element problems are  
considered. Algorithms for calculation and construction of elements of reinforced  
concrete and steel structures in the environment of the software complex LIRA-SAPR  
are given.

UDC 69.04

© Soroachak A.,.....2022  
© Ternopil Ivan Puluj National Technical  
Universit..... 2022

## Contents

Introduction .....	5
Laboratory work № 1. Static calculation of a beam.....	6
Laboratory work № 2. Static calculation of a flat frame .....	8
Laboratory work № 3. Stress-strain state calculation of the wall-beam .....	11
Laboratory work № 4. Cylindrical tank calculation.....	13
Laboratory work № 5. Calculation of the flat combined system using super- elements.....	16
Laboratory work № 6. Reinforcement of concrete elements .....	18
Laboratory work № 7. Calculation and design of reinforced concrete slab .....	21
Laboratory work № 8. Calculation and design of a steel frame .....	23
Laboratory work № 9. Truss calculation and design.....	26
Laboratory work № 10. Combined 3D-model calculation .....	28
Laboratory work № 11. Frame dynamic calculation.....	30
Laboratory work № 12. Calculation and design of a steel tower.....	32
Laboratory work № 13. Base slab calculation with foundation bed.....	35
Laboratory work № 14. Construction calculation with 3D soil modelling.....	36
Laboratory work № 15. Calculation and design of industrial building frame .....	40
Laboratory work № 16. Cabling truss calculation .....	42
Laboratory work № 17. Nonlinear calculation of the beam taking into account the creep of concrete.....	44
Laboratory work № 18. Calculation of reinforced concrete frame in a physically nonlinear formulation .....	47
Recommended books .....	50

## **Introduction**

The use of advanced information technology is the key to successful calculations at the design stage of new buildings and structures, as well as when checking the load-bearing capacity of existing ones. Nowadays, there are a large number of computer-aided design (CAD) systems for construction projects, which are designed to consider certain parts of the project: architectural (ArchiCAD, Revit), structural (SCAD, LIRA, Robot Structure Analysis), electrical (OrCAD), graphic (AutoCAD, COMPASS) and others. The results obtained with their help can significantly improve the quality and speed of solving relevant engineering problems.

Adoption of technically reasonable decisions, supported by appropriate calculations, is the most important stage of design. Therefore, it is essential for students to master modern CAD tools for design and calculations for the strength, stability and rigidity of the elements of building structures. To do this, students of speciality 192 «Construction and Civil Engineering» in the course «Software for Engineering Design» are taught the basics of practical work with the design and computing complex LIRA-SAPR.

The guidelines are aimed at assisting students in performing laboratory works on this course and include examples of solving typical problems with PC LIRA-SAPR, contain information about the structure of the complex, design features of PC LIRA-SAPR for metal and reinforced concrete structures, dynamic and nonlinear calculations.

## Laboratory work № 1. Static calculation of a beam

**Aim of work:** familiarize with an interface the LIRA software tool and order of implementation of the basic stages of design model creation; perform the static calculation of simple beam and analysis of the results.

### 1. Task.

Familiarize with the purpose of the default buttons on the toolbar and menu commands of the LIRA software graphic user interface.

Perform the calculation of beam on the static loading in obedience to a variant. Display the deformed chart, diagrams of moments and shear forces. Analyse the results.

Table 1.1 – Given for a calculation

Variant	Model chart	Cross-section	$l$ , m	$a_1$ , m	$a_2$ , m	$F$ , kN	$M$ , kN·m	$q$ , kN/m
1		┆ IPN 300	5	2	1.5	5	-	1
2		┆ UAP 220	7.5	4	5	8	-	2
3		┆ HEA 195 400	10	6	3	9	-	3
4		┆ HEB 150 300	5	2	1.5	5	-	3
5		┆ IPE-A 360	7.5	4	3	7	-	2
6		┆ UPN 220	10	5	4	8	-	1
7		┆ UAP 300	5	2.5	2	10	-	3
8		┆ HEA 165 340	7	3	1.5	8	-	4
9		┆ IPE-A 400	7	5	1	9	-	5
10		┆ HEB 200 400	5	2.5	2	-	15	3
11		┆ UPN 300	7	3	1.5	-	10	4
12		┆ IPN 260	7	5	1	-	8	5
13		┆ HEA 175 360	5	2.5	2	-	6	3
14		┆ UPN 260	7	3	1.5	-	10	2
15		┆ IPE-A 300	7	5	1	-	15	4

### 2. Task processing.



1. Run the LIRA software tool.

Execute a Windows command *Start => Programs => LIRA SAPR => ЛИРА-САПР 2015=>ЛИРА-САПР 2015.*

2. Creation of a new problem.

On the toolbar press the button  *New*. In the dialog box **Model type** set the problem name «LWI» and model type «2».



### 3. Creation of a geometrical model of a beam.





On the *Create and edit* ribbon press the button  *Create Regular Fragments and Grids*. On the tab **Create frame** set the step of finite elements (FE)  $L=0.5$  m and the number of steps along a horizontal axis (N). Press the button  *Apply* and close a dialog box.

### 4. Save the problem.







Save a problem by pressing the button  *Save*. In the dialog box **Save As** set the file name and folder where it will be saved.

### 5. Restraints assignment.

Show out the numbers of design model nodes on a screen. For this purpose on the toolbar press the button  *Flags of Drawing*, in a dialog box go to the tab **Nodes**, set the flag  *Node Numbers* and press the button  *Redraw*.



To select separate nodes press the button  *Select Nodes* on the toolbar and pick them with the left mouse button click. The selected nodes will be displayed in red colour. To remove the selection of nodes, press the button  *Unselect All*. Select nodes on beam seats and press the button  *Restraints*. In the dialog box **Restraints on Nodes** activate tab **Impose Restraints**, select flags for directions for which nodes displacements are inhibited (X, Z – for hinged immovable support, Z – for hinged movable support) and press  *Apply*.

### 6. Stiffness assignment for elements.

Using the button  *Select Elements* select all elements of the beam, they will be painted out in red colour. Press the button  *Material properties* on the ribbon. In the dialog box **Stiffness and materials** press the button *Add>>*, choose tab **Database of steel sections** and set a sectional shape in obedience to the variant. In the dialog **Stiffness and materials** press the button  *Apply*. Selection from elements will be removed; that means that the chosen type of stiffness is correctly assigned to elements. For stiffness verification press the button  *Flags of Drawing*, in a dialog box go to the tab **Elements**, set the flag  *Type of Stiffness* and press the button  *Redraw*.

### 7. Loading assignment.

For the loading assignment select the necessary elements of the model and press the button  *Loads* on the ribbon. In the dialog box **Define loads** go to the necessary tab (**Loads on Nodes** or **Loads on Bars**). Choose the global coordinate system, loading direction and its type (concentrated force, moment or distributed load). Directions of global coordinate axes are shown in the left lower corner of the screen. Assign a value for the chosen type of loading in obedience to the variant. For confirmation of the correct choice of parameters

press the button  *Apply*. Editing of loading value is possible on the tab **Edit loads** of dialog box **Define loads**. To delete loading on a certain element of the design model select it and press the button  *Delete Load for Selected Objects* on the ribbon.

#### 8. Problem calculation.

To start problem calculation press the button  *Analyse* on the *Analysis* ribbon. The calculation processor of the LIRA software will execute verification of the design model to the presence of errors and will show out a report in a text file.

#### 9. Calculation results analysis.

To pass to the mode of results visualization and analysis press switch to the *Results* ribbon.

To draw the output diagrams of forces and moments in a beam press the corresponding button **Q<sub>z</sub>**, **M<sub>v</sub>** on the ribbon. Display numerical values on the diagram with  *Values on Diagrams* button.

To save the image with current results displayed on the screen press the button  *Screenshot* on the right-side panel.

### 3. Control questions.

1. Basic instruments of the LIRA software graphic user interface and their purpose.
2. A general order of design model creation.
3. Creation of design model elements geometry. Global and local systems of coordinates.
4. Stiffness assignment for design model elements.
5. Loading assignment to the elements of design model; loading types.
6. Analysis and visualization of calculation results for the design model.

### Laboratory work № 2. Static calculation of a flat frame

**Aim of work:** familiarize with the order of loading assignment; perform a static calculation of a flat frame and analysis of the results.

#### 1. Task.

Perform the calculation of a flat frame on the static loading in obedience to a variant. Draw the deformed chart, diagram of bend moments, normal and transversal forces and analyse the results.

The material of the frame is the reinforced concrete. Perform calculation on three load cases: the first one is dead distributed load ( $q_1, q_2, q_3$ ); the second one is live load ( $q_4; q_5$ ); the third one is wind  $P_1, P_2, P_3 = 0,75P_1, P_4 = 0,75P_2$ .



## 2. Task processing.

1. Run the LIRA software tool.

Execute a Windows command *Start => All Programs => LIRA SAPR => ЛИРА-САПР 2015 => ЛИРА-САПР 2015.*

Table 2.1 – Given for calculation.

Variant	$H_1$ , m	$H_2$ , m	$L_1$ , m	$L_2$ , m	$B_c$ , cm	$H_c$ , cm	$B_{b1}$ , cm	$B_b$ , cm	$H_b$ , cm	$H_{b1}$ , cm	$q_1$ , kN/m	$q_2$ , kN/m	$q_3$ , kN/m	$q_4$ , kN/m	$q_5$ , kN/m	$P_1$ , kN	$P_2$ , kN
1	6	4	4	3	40	60	40	20	60	20	20	15	30	40	20	15	10
2	6	4	4	3	40	50	30	15	55	20	20	10	25	40	30	15	8
3	6	3	4	4	40	40	35	18	50	15	20	10	20	40	15	12	8
4	6	5	4	5	45	40	40	18	65	25	15	30	20	30	15	15	12
5	6	5	4	5	45	60	45	25	55	15	15	20	30	30	20	12	10
6	5	5	5	4	45	45	55	25	65	25	15	10	20	20	40	15	10
7	5	4	5	4	45	50	50	25	60	20	15	15	20	30	40	15	8
8	5	4	5	3	40	50	50	20	60	25	30	20	15	15	30	17	2
9	5	5	5	3	40	60	40	25	60	15	30	15	10	20	30	15	12
10	5	3	5	4	40	40	50	25	65	20	25	15	20	30	15	17	15
11	4	3	6	4	30	30	60	30	60	15	25	20	15	20	15	17	10
12	4	3	6	5	30	40	60	25	70	25	20	20	10	20	25	15	10
13	4	4	6	3	30	45	50	20	60	20	15	20	15	15	30	15	12
14	4	4	6	3	35	35	45	25	65	20	15	15	20	15	25	17	12
15	4	4	6	5	35	45	60	25	65	25	15	10	15	15	20	15	10

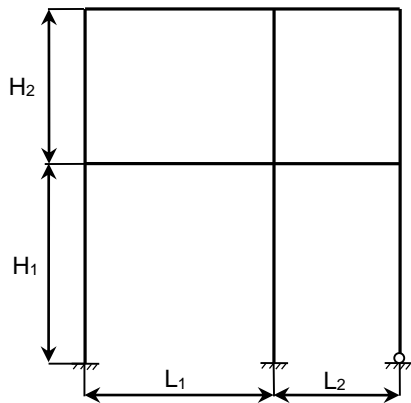

Figure 2.1 – Frame schema

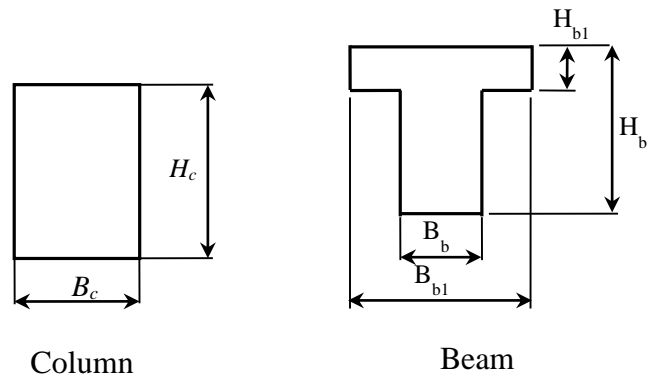

Figure 2.2 – Section shapes of frame elements

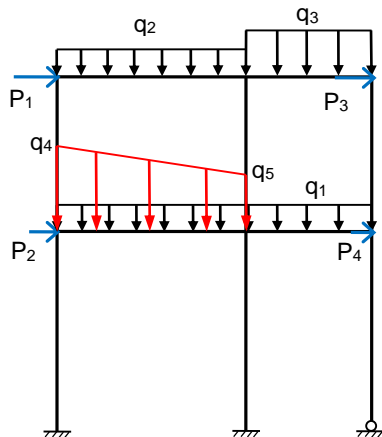





Figure 2.3 – Loadings on frame



2. Creation of a new problem.



On the toolbar press the button  *New*. In the dialog box **Model type** set the problem name «LW2» and model type «2».

### 3. Creation of a geometrical model of the frame.

On the toolbar, press the button  *Create Regular Fragments and Grids*. On the tab **Create frame** set the step of finite elements (FE) and amount of steps along horizontal and vertical axes. Press the button  *Apply* and close a dialog box.



### 4. Restraints assignment.



Show out the numbers of nodes and elements on a screen. For this purpose on the toolbar press the button  *Flags of Drawing*, in a dialog box go to the tab **Nodes**, set the flag  *Node Numbers* and press the button  *Redraw*.

Select nodes on column seats and press the button  *Restraints*. In the dialog box **Restraints on Nodes** activate tab **Impose Restraints**, select flags for directions for which nodes displacements are inhibited (X, Z, UY – for fixed support, X, Z – for hinged immovable support) and press  *Apply*.



### 5. Stiffness assignment for frame elements.



Press the button  *Material properties* on the ribbon. In the dialog box **Stiffness and materials** press the button *Add>>*, choose tab **Standard types of sections** and set a sectional shape in obedience to the variant. In the dialog box **Define standard section** enter the parameters: the modulus of rigidity  $E = 3e7 \text{ kN/m}^2$ , material density  $R_0 = 25 \text{ kN/m}^3$ .

Using button  *Select Elements* select all columns of the frame, they will be painted out in red colour. In the dialog **Stiffness and materials** press the button  *Apply*. Selection from elements will be removed; it means that the chosen type of stiffness is correctly assigned to elements.

Select T-section type of stiffness in a list and press the button **Set as current one**. Using button  *Select Elements* select all beams of the frame, they will be painted out in red colour. In the dialog **Stiffness and materials** press the button  *Apply*.

### 6. Loading assignment.

For the loading assignment select the necessary elements of the model and press the button  *Loads* on the ribbon. In the dialog box **Define loads** go to the tab **Loads on Bars**. Choose the global coordinate system, loading direction and its type. Directions of global coordinate axes are shown in the left lower corner of the screen. Assign a value for the chosen type of loading in obedience to the variant. For confirmation of the correct choice of parameters press the button  *Apply*.

Change the load case number to «2» by the meaning of the button  *Next Load Case* on the bottom toolbar. Select the elements of model, on which the live loading operate, press the button  *Loads* on the ribbon and assign a value of loading in obedience to the variant.

Change the load case number to «3», select nodes of the model on which the wind load operate. In the dialog box **Define loads** go to the tab **Loads on Nodes** and assign a value of loading in obedience to the variant tacking into account direction along X axis.

#### 7. Design sections edit.

To perform detailing of the element which works on a bend it is required to calculate internal forces in three or more sections of the element. Select the horizontal elements of the model. Switch to *Bars* ribbon and press the button  *Design Sections of Bars*. In the dialog box **Design Sections** set the number of design sections  $N = 7$ .

#### 8. Save the file.

#### 9. Problem calculation.

To start problem calculation press the button  *Analyse* on the *Analysis* ribbon.

#### 10. Calculation results analysis.

To pass to the mode of results visualization and analysis switch to the *Results* ribbon.

To draw the output diagrams of forces and moments in a frame elements press button for the corresponding type of diagram on the ribbon **N**, **Qz**, **Mv**. To draw the diagrams for different load cases choose the number of required load case on the bottom toolbar.

### 3. Control questions.

1. Creation of design model geometry for a flat frame.
2. Restraints assignment in the nodes of the design model.
3. Stiffness types in LIRA software.
4. Load cases creation for the design model.
5. Design sections for bar elements and their edit.
6. Analysis and visualization of calculation results for a flat frame.

### Laboratory work № 3. Stress-strain state calculation of the wall-beam

**Aim of work:** familiarize with calculation procedure of principal and equivalent stresses in planar elements; perform a calculation of the stress-strain state of the wall-beam.

#### 1. Task.

Perform calculation of a wall-beam with  $a \times b$  dimensions and thickness  $H$ . Wall has restrains on the bottom side (fig 3.1) and loadings on the top in obedience to a

variant (table 3.1). Provide principal and equivalent stresses calculation using finite elements mesh with 0.5 m step.

## 2. Task processing.

### 1. New problem creation.

On the toolbar press the button  *New*. In the dialog box **Model type** set the problem name «*LW3*» and model type «*1*».

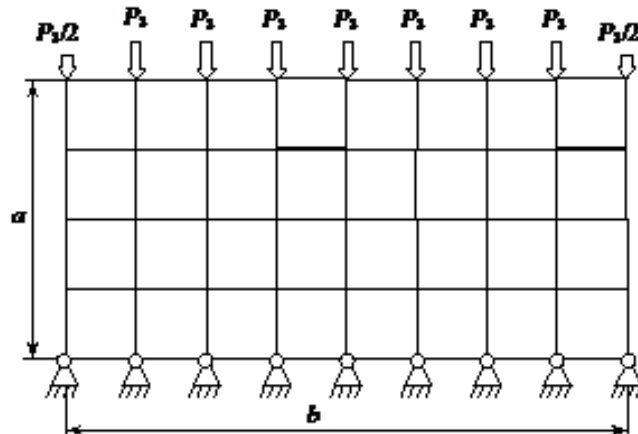

Figure 3.1 – Design model of a wall-beam

Table 3.1 – Given for calculation



VARIANT	$a$ , m	$b$ , m	$H$ , cm	$P$ , kN
1	3	6	15	15
2	4	8	20	12
3	5	10	30	12
4	3	6	15	12
5	4	8	25	10
6	5	10	30	10
7	3	6	20	13
8	4	8	20	10

VARIANT	$a$ , m	$b$ , m	$H$ , cm	$P$ , kN
9	5	10	25	8
10	3	6	15	13
11	4	8	25	13
12	5	10	30	8
13	3	6	15	8
14	4	8	25	10
15	5	10	25	8

### 2. Creation of geometrical model.

On the toolbar, press the button  *Create Regular Fragments and Grids*. On the tab **Create wall-beam** set the step of finite elements (FE) and amount of steps along horizontal and vertical axes. Press the button  *Apply* and close a dialog box.

### 3. Restraints assignment.

Select all nodes on the bottom side of a wall and press the button  *Restraints*. In the dialog box **Restraints on Nodes** activate tab **Impose Restraints**, select flags for directions for which nodes displacements are inhibited (X, Z) and press  *Apply*.

#### 4. Stiffness assignment.

Press the button  *Material Properties*. In **Stiffness and Materials** dialog window press the button **Add**, choose tab **Plates, solids, numerical** and select *Plates*. In the dialog box **Specify stiffness for plates** enter the parameters: the modulus of rigidity  $E = 3e7 \text{ kN/m}^2$ , Poisson's ratio  $\nu = 0.2$ ,  $R_0 = 25 \text{ kN/m}^2$ . Set this stiffness type as current and assign it to all FE.

#### 5. Loadings assignment.

Select nodes on the top of a wall-beam and assign vertical loadings in obedience to your variant.

#### 6. Problem calculation and results analysis.

Perform problem calculation with  *Analyse* button on the *Analysis* ribbon.

Switch to the *Results* tab and display on the screen  *Displacement Contour Plot* along Z axis.

#### 7. Principal and equivalent stress calculation and analysis.

On the *Advanced results* ribbon press the  *Analysis (LITERA)* button. In dialog window **Calculate principal and equivalent stresses** check *Principal* and *Equivalent* options, select *Maximum principal stress criterion* as criteria of rupture and press **Analyse** button.

Display on the screen *Contour Plot of Principal and Equivalent Stress* for  $N_1$ ,  $N_3$ ,  $N_4$ .

### 3. Control questions.

1. Design model creation for a wall-beam.
2. Principal stresses.
3. Equivalent stress.
4. Order of principal and equivalent stresses calculation.
5. Main criteria of rupture.

## Laboratory work № 4. Cylindrical tank calculation

**Aim of work:** become familiar with symmetric models calculation features; provide static calculation of a cylindrical tank.

### 1. Task.

Provide static calculation of a cylindrical concrete tank with radius  $R$  and height  $H$  (table 4.1). Bottom thickness –  $h$ , wall thickness –  $d$ . Provide calculation on water pressure that changes with height. Use symmetry conditions in a calculation to reduce model size.

Table 4.1 – Given for calculation

Variant	R, m	H, m	d, cm	h, cm
1	2	3	15	20
2	2	3	20	25
3	3	3	15	25
4	3	3	15	30
5	3	4	20	25
6	3	4	20	30
7	3	4	25	30
8	2.5	3	15	20

Variant	R, m	H, m	d, cm	h, cm
9	2.5	3	20	25
10	3	3.5	20	25
11	3	3.5	20	30
12	3	3.5	15	20
13	3	3.5	15	25
14	2.5	3.5	15	25
15	2.5	3.5	20	25

## 2. Task processing.

### 1. Creation of a new problem.



Create a new file. In the dialog box **Model type** set the problem name «*LW4*» and elements type «5».

### 2. Geometrical model creation.



On the ribbon press the  *Surface of Revolution* button. In dialog window **Surfaces of Revolution** go to cylinder generation tab and set parameters according to your variant:  $R$ ,  $H$ ,  $n1 = 20$ ,  $n2 = 9$ ,  $f_i = 90^\circ$ . Leave default values for other parameters.

In dialog window **Surfaces of Revolution** go to cone generation tab and set parameters:  $r = 0$  m;  $R$ ;  $H = 0$  m;  $n1 = 10$ ;  $n2 = 9$ ;  $f_i = 90^\circ$ .



### 3. Model packing.

On the ribbon press the  *Pack Model* button. In the dialog window **Pack Model** leave default parameters and press  *Apply* button.

### 4. Local coordinate system assignment.

Select all nodes of a model. Switch to the *Nodes* ribbon and press  *Local Nodal Axes* button. In dialog window **Local axes of nodes** uncheck coordinate  $Z2$  and press  *Apply* button. This will create a cylindrical coordinate system for the existing model.

### 5. Restraints assignment.

Select all nodes. Press the  *Restraints* button and select restraints directions that correspond to symmetry conditions – Y, UX and UZ. Press  *Apply* button.

Select nodes where the wall and bottom of tank joints and assign additional restraints on Z axis to them.

### 6. Stiffness assignment.

On the ribbon press the  *Material Properties* button. In the dialog window **Stiffness and materials** create 2 stiffness types: press *Add* button, go to *Plates, solids, numerical* tab and double click on *Plates* stiffness type. Set parameters:

- modulus of rigidity –  $E = 3e7 \text{ kN/m}^2$ ;
- Poisson coefficient –  $\nu = 0.2$ ;
- bottom thickness  $h$ ;
- $R_o = 25 \text{ kN/m}^3$ .

In the dialog window **Stiffness and materials** select created stiffness type and press the *Copy* button. Edit copied stiffness type and set wall thickness  $d$ .

Assign created stiffness types to bottom and wall model elements. For the easier selection of corresponding finite elements, you may use  *Select Block* button on the bottom toolbar.



#### 7. Loadings assignment.



Select bottom elements and assign water pressure to them. On the ribbon press the button , go to **Loads on plates** tab, set global coordinate system, loading direction –  $Z$ , and distributed value –  $10 \text{ kN/m}^2$  for each meter of tank height.

Water pressure on the tank wall is changing with height – from 0 on the top to maximal value on the bottom. On the ribbon press the button , go to **Stiffness of elements** tab, set local coordinate system, loading direction –  $Z$  and enter non-uniformly distributed values –  $P1 = 0$ ,  $P2$  equal to load on the bottom, changes along  $Z$  axis.

#### 8. Provide problem calculation.

#### 9. Results analysis.

Select all bottom elements. On the bottom toolbar press the button  *Inverse Fragmentation*. On the *Analysis* ribbon draw  *Displacement Contour Plot in Local Coordinate System* along local  $X(L)$  axis. To restore the previous view on the model press the  *Restore Model* button on the bottom toolbar.

Select all bottom elements. On the bottom toolbar press the button  *Fragmentation*. Draw  *Displacement Contour Plot in Global Coordinate System* along global  $Z(G)$  axis.

To find out maximal stresses in the bottom wall elements press the  *Information about Nodes and Elements* button on the bottom toolbar and click on one of those elements.

### 3. Control questions.

1. 3D models geometry creation.
2. Symmetry conditions in the calculation.
3. Model packing.
4. Local coordinate system.
5. Results analysis for 3D models.

## Laboratory work № 5. Calculation of the flat combined system using super-elements

**Aim of work:** familiarize with the peculiarities of the calculation using the super-element approach; provide calculation of a flat combined system using super-elements.

### 1. Task.

Perform a static calculation of the transverse diaphragm of the building, made of beams-walls with a thickness  $h$  and frame bars (fig. 5.1) using super-elements according to your variant (table 5.1). Parameters of stiffness of columns and beams of a frame should be taken from laboratory work № 2. Perform calculation for two loads – from dead weight and long-term  $q$ .

### 2. Task processing.

#### A. Creation of the super-element of type I.

1. New model creation.

On the main toolbar press the button  *New*. In the dialog box **Model type** set the problem name «LW5-SE1» and the model type «5».

Table 5.1 – Given for calculation.

Variant	$a$ , m	$b$ , m	$h$ , cm	$L$ , m	$H$ , m	$q$ , kN/m
1	3	3	20	4	3.5	5
2	3	4	25	4	3.5	8
3	4	3	15	3	3.5	8
4	4	4	10	3	3.5	10
5	3	3	15	4	3	9
6	3	4	25	4	3	6
7	4	3	20	3	3	7
8	4	4	18	3	3	5
9	3	3	13	4	4	8
10	3	4	20	4	4	7
11	4	3	25	3	4	10
12	4	4	10	3	4	10
13	3	4	18	3	4	9
14	3	4	15	3	3.5	8
15	4	4	13	4	3	5

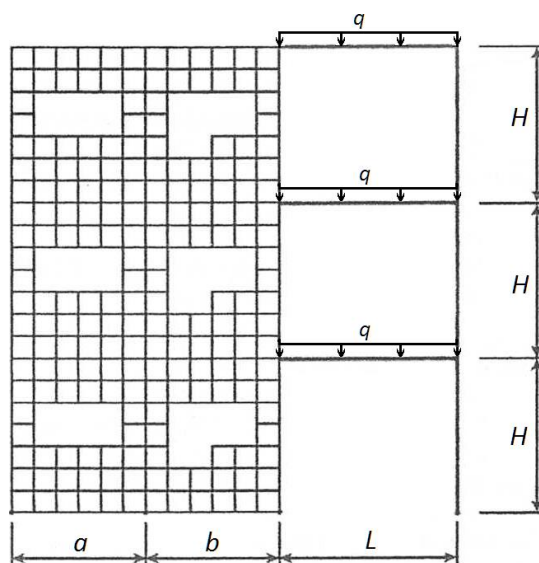





Figure 5.1 – Drawing of a system.



2. Geometrical model creation.

On the ribbon, press the  *Create Regular Fragments and Grids* button. On the tab **Create wall-beam** set the FE step 0.5 m along horizontal and vertical axes and the required number of FEs. Press the button  *Apply* and close a dialog box.

To form a 2x1 m cut-out, select its internal nodes and press the button  *Delete Selected Objects*.



### 3. Model packing.

On the ribbon press the  *Pack Model* button. In the dialog window **Pack Model** leave default parameters and press  *Apply* button.



### 4. Stiffness assignment.

Press the button  *Material Properties*. In the **Stiffness and Materials** dialog window press the button **Add**, choose tab **Plates, solids, numerical** and select *Plates*. In the dialog box **Specify stiffness for plates** enter the parameters: the modulus of rigidity  $E = 3e7 \text{ kN/m}^2$ , Poisson's ratio  $\nu = 0.2$ ,  $R_0 = 25 \text{ kN/m}^2$ . Set this stiffness type as current and assign it to all FE.

### 5. Loadings assignment.

On the ribbon, press the button  *Add Dead Weight*, select option *All elements* and press  *Apply* button.

### 6. Super-nodes assignment.

Select nodes on the corners of a wall. On the *Advanced edit options* ribbon press the button  *Super-nodes*. In the dialog window **Super-nodes** go to tab **Assign super-nodes** and press  *Apply* button. Selected nodes will become painted in olive colour. In the dialog window **Super-nodes** go to tab **Assign basic super-nodes** and select one by one 3 corner nodes that will determine the orientation of the super-element in the main model. They will be painted in crimson, yellow and blue.

### 7. Save the model.

Save created super-element by pressing the button  *Save*. In the dialog box **Save As** set the file name and folder where it will be saved.

## ***B. Creation of the super-element of type II.***



8. Repeat steps 1–7 to create another type of super-element and save it in a new file named «*LW5-SE2*».

## ***C. Creation of the main model.***

### 9. New problem creation.

On the main toolbar press the button  *New*. In the dialog box **Model type** set the problem name «*LW5*» and the model type «*5*».

### 10. Geometrical model creation.

On the toolbar, press the button  *Create Regular Fragments and Grids*. On the tab **Create frame** set the step of finite elements and the number of steps along horizontal and vertical axes. Press the button  *Apply* and close a dialog box.

Select and remove the frame elements in the first two spans so that the corresponding nodes remain in the model. Display the node numbers and pack the model.

### 11. Restraints assignment.

Select all nodes of the model and add restrains along Y, UX, UZ for them. For all bottom nodes additionally add restrains along X, Z, UY.

### 12. Stiffness assignment.

Create and assign stiffness for columns and beams according to your variant for laboratory work № 2.

### 13. Insertion of super-elements into the main model.

On the *Advanced edit options* ribbon press the button **S<sup>+</sup> Add Super-element**. In the dialog window **Add super-element** press the button **Select** and open a file with super-element of type I. To insert it, sequentially point to the three nodes of the main model to which the base super-nodes should be joined. After selecting each of the three nodes, press the **Apply** button. There should be 3 super-elements of this type.

Repeat this step to insert 3 super-elements of type II.

Pack the model.

### 14. Loadings assignment.

Add dead weight for all elements of the model.

Select all super-elements and press the button **! Loads** on the ribbon. In the dialog box **Define loads** go to the tab **Super-load** and press the button **Super**. In the dialog window **Super-load** enter the number of load case to import from super-element's file – 1, coefficient – 1 and press **Apply** button.

Switch to load case № 2 and assign loadings on beams according to your variant.

### 15. Problem calculation.

### 16. Calculation results analysis.

Switch to the *Results* ribbon and press the button **Initial Model** to display initial state of the model. Display the diagrams of **N**, **Q<sub>z</sub>**, **M<sub>y</sub>** for bars. Display stresses **N<sub>x</sub>**, **N<sub>y</sub>**, **τ<sub>xy</sub>** for elements of beam-wall.

## 3. Control questions.

1. Principles of super-element approach in the calculation of FEM problems.
2. The order of creation of super-elements.
3. The sequence of inserting super-elements into the main model.
4. Inclusion of super-loads when calculating the model.
5. Visualization of the results of the calculation of the model with super-elements.

## Laboratory work № 6. Reinforcement of concrete elements

**Aim of work:** familiarize with the order of concrete elements reinforcing; perform a calculation of reinforced concrete elements of a flat frame.

## 1. Task.

Perform calculation and design of reinforced concrete elements of a flat frame (beams and columns) based on results received after calculations in laboratory work № 2.

## 2. Task processing.



1. Run the LIRA-SAPR software tool.

Execute a Windows command *Start => All Programs => LIRA SAPR => ЛИРА-САПР 2015 => ЛИРА-САПР 2015*.



2. Save data.

Open the file with laboratory work № 2 results. Save data as a new file «LW6».

3. Design combination of loadings creation.

Switch to the *Analysis* ribbon and press the  *DCL* button. From the list select building codes – *Eurocode*, set load case types (1st – *Dead*, 2nd – *Live*, 3rd – *Wind*), press **Add** button on the bottom to assign coefficients for a linear combination of loadings and save changes with  *Save data* button.

4. Set of material parameters.

Press on the button  *Material Properties* on the ribbon. In the **Stiffness and Materials** dialog window choose building codes – *Eurocode 2*. In the **Design options** dialog window select analysis of sections by *DCL* and press  *Apply* button.

In the **Stiffness and Materials** dialog switch to the *RC* tab, select radio-button *Type* and press the **Add** button. In the dialog window **General parameters** set following data for columns:

- Select module of reinforcement *Bar*;
- Select *Symmetric* reinforcement type;
- Select radio-button *Effective length factor* and set parameters  $L_Y = 0.7$ ,  $L_Z = 0.7$ ;
- Select radio-button *Column* and uncheck flag *Do not account design requirements*;
- Set *Analysis according to serviceability limit states* checkbox.

Other parameters leave as default and press on the  *Apply* button.

Repeat steps to create a type of material for beams with the following parameters:

- Select *Asymmetric* reinforcement type;
- Set *Effective length factor*  $L_Y = 0$ ,  $L_Z = 0$ ;
- Select radio-button *Beam* and unselect flag *Do not account design requirements*;

- Set *Analysis according to serviceability limit states* checkbox.

In the **Stiffness and Materials** dialog window select radio-button *Concrete* and press the **Add** button. In the dialog window **Concrete** select class of concrete C30, type of concrete *Heavyweight* and *Bilinear model*. Other parameters leave as default and press on the  *Apply* button.

In the **Stiffness and Materials** dialog window select radio-button *Reinforcement* and press the **Add** button. In the dialog window **Reinforcement** set reinforcement class A400 for longitudinal and A220 for transverse reinforcement. Other parameters leave as default and press on the  *Apply* button.

#### 5. Material properties assignment.

In the **Stiffness and Materials** dialog window select type *1. Bar* (for columns) and press **Set as current one** button. Select all vertical elements of the frame (columns) and in the **Stiffness and Materials** dialog window press  *Apply* button.

After that in the **Stiffness and Materials** dialog window select type *2. Bar* (for beams) and press **Set as current one** button. Select all horizontal elements of the frame, in the **Stiffness and Materials** dialog window press the  *Apply* button.



#### 6. Structural elements assigning.

Select all finite elements of the design model. Switch to the **Bars** ribbon and press the  *Structural Elements* button. In the dialog window **Structural Elements** press the **Generate StE** button.

#### 7. Reinforcing calculation.





Switch to the *Analysis* ribbon and press the  *Analyse* button.

#### 8. Reinforcing results analysis.

Switch to *Design* ribbon. To display on the screen area of required reinforcement for columns click on the  *Symmetric* button, after that click on the  *Total reinforcement* button and add summarize all reinforcements. Switch to  *Asymmetric* mode and summarize total reinforcement for beams.

Generate a table with reinforcing calculation results for all elements with the  *Tables of results* button and save it.

#### 9. Column and beam design.

To generate drawings of reinforced concrete elements automatically press on the buttons  *Beam* or  *Column* respectively and select the element of the design model. In the dialog window press the  *Analyse* button and then the  *Drawing* button.

### 3. Control questions.

1. Assigning of material properties to perform reinforcing calculation.

2. Symmetric and asymmetric reinforcement.
3. Structural elements assigning.
4. Reinforcement calculation results.
5. A general order of reinforced concrete elements design. Drawings generation.

### Laboratory work № 7. Calculation and design of reinforced concrete slab

**Aim of work:** familiarize with design model creation of two-dimensional elements; perform a static calculation of slab and its reinforcing.

#### 1. Task.

Perform calculation of concrete slab with dimensions  $a \times b$  and thickness  $H$  according to your variant. One short side of the slab is supported by the wall on the whole length, opposite side – by two columns on corners. Perform reinforcing calculation on 3 load cases: 1 – the dead weight, 2 & 3 – concentrated forces  $P_2$  and  $P_3$ .

Table 7.1 – Given for calculation

Variant	$a$ , m	$b$ , m	$H$ , cm	$P_2$ , kN	$P_3$ , kN
1	3	6	15	20	15
2	4	8	20	15	12
3	5	10	30	15	12
4	3	6	15	15	12
5	4	8	25	15	10
6	5	10	30	13	10
7	3	6	20	18	13
8	4	8	20	13	10
9	5	10	25	12	8
10	3	6	15	18	13
11	4	8	25	15	13
12	5	10	30	12	8
13	3	6	15	12	8
14	4	8	25	13	10
15	5	10	25	10	8

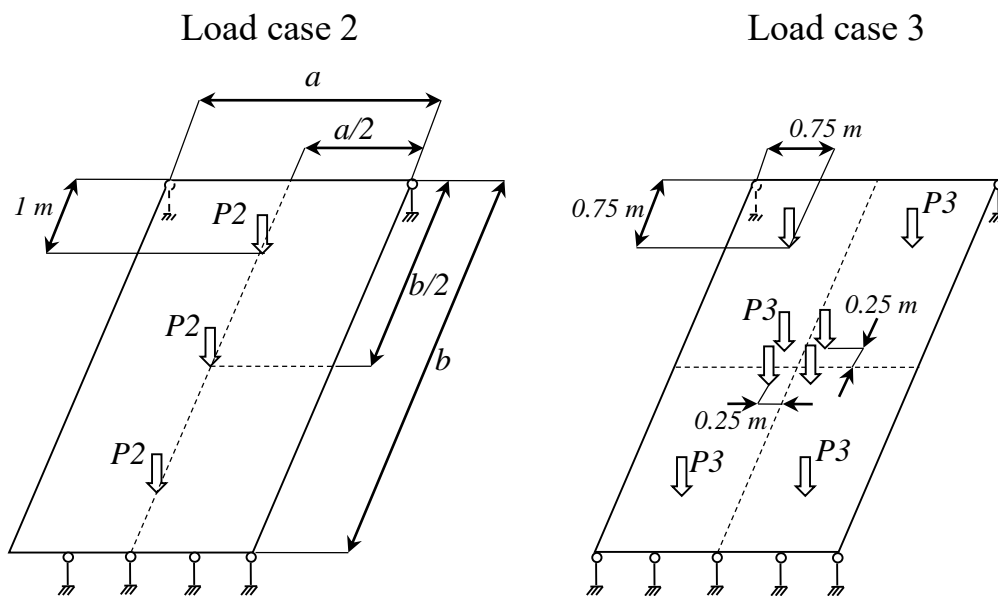

Figure 7.1 – Design model of the slab

## 2. Task processing.

### 1. Creation of a new problem.

On the toolbar, press the button *Create Regular Fragments and Grids*. On the tab **Create slab** set the step of finite elements (FE) – 0.5 m – and the number of steps along X and Y axes according to your variant. Press the button *Apply* and close a dialog box.

### 2. Restraints assignment.

Select all nodes of slab bearing and press the button *Restraints*. In the dialog box **Restraints on Nodes** select flags for directions for which nodes displacements are inhibited (Z) and press *Apply*.

### 3. Stiffness assignment for slab elements.

Press the button *Material Properties*. In the **Stiffness and Materials** dialog window choose building codes – *Eurocode 2*. In the **Design options** dialog window select analysis of sections by *DCL* and press *Apply* button.

In the **Stiffness and Materials** dialog box press the button **Add**, choose tab **Plates, solids, numerical** and select *Plates*. In the dialog box **Specify stiffness for plates** enter the parameters: the modulus of rigidity  $E = 3e7 \text{ kN/m}^2$ , Poisson's ratio  $\nu = 0.2$ ,  $R_0 = 25 \text{ kN/m}^2$ . Set this stiffness type as current and assign it to all slab's FE.

### 4. Material properties assignment.

In the **Stiffness and Materials** dialog switch to the *RC* tab, select radio-button *Type* and press the **Add** button. In the dialog window **General parameters** set module of reinforcement – *Slab* and set *Analysis according to serviceability limit states* checkbox. Other parameters leave by default and press *Apply* button.



In the **Stiffness and Materials** dialog window select radio-button *Concrete* and press the **Add** button. In the dialog window **Concrete** select class of concrete C30, type of concrete *Heavyweight* and *Bilinear model*. Other parameters leave as default and press on the  *Apply* button.

In the **Stiffness and Materials** dialog window select radio-button *Reinforcement* and press the **Add** button. In the dialog window **Reinforcement** set reinforcement class A400 for longitudinal and A220 for transverse reinforcement. Other parameters leave as default and press on the  *Apply* button. Assign created material properties to all slab's FE.

#### 5. Loading assignment.



In the first load case assign the dead weight for all elements by  *Add Dead Weight* button. In second and third load cases assign concentrated forces  $P_2$  on nodes and  $P_3$  on the centre of FE.





#### 6. Problem calculation and results analysis.

Switch to the *Analysis* ribbon and press the  *DCL* button. From the list select building codes – *Eurocode*, set load case types (*Dead* for the 1st, *Live* for 2nd & 3rd), press **Add** button on the bottom to assign coefficients for a linear combination of loadings and save changes with  *Save data* button.

Perform problem calculation with  *Analyse* button.

#### 7. Results analysis.

Switch to *Results* ribbon, enable  *Results by DCL* mode and display on the screen  *Displacement Contour Plot* along Z axis and  *Stress Contour Plots* for  $M_x$ ,  $M_y$ ,  $Q_x$ ,  $Q_y$ .

Switch to *Design* ribbon and display upper (, ) and lower (, ) reinforcements for slab. Generate a table with reinforcing calculation results for all elements with the  *Tables of results* button and save it.

### 3. Control questions.

1. Design model creation of two-dimensional elements.
2. Loading assignment on a plate.
3. Results analysis of plate calculation.
4. Assigning of material properties to perform reinforcing calculation.
5. Reinforcing calculation results for a plate.

## Laboratory work № 8. Calculation and design of a steel frame

**Aim of work:** familiarize with main features of steel constructions calculation; perform a static calculation of flat frame and analysis of the results.

## 1. Task.

Perform calculation and design of the elements of steel flat frame (beams and columns) using schema from laboratory work № 2.

Table 8.1 – Given for calculation.

Variant	Beam sectional shape and material	Column sectional shape and material
1	I-Section IPN 300 (Fe E 275)	Box of channels UPN 220 (Fe E 235)
2	I-Section IPN 260 (Fe E 235)	Box of channels UPN 180 (Fe E 335)
3	I-Section IPN 180 (Fe E 355)	Box of channels UPN 240 (Fe E 235)
4	I-Section IPN 280 (Fe E 235)	Box of channels UPN 260 (Fe E 275)
5	I-Section IPN 240 (Fe E 275)	Box of channels UPN 240 (Fe E 335)
6	Box of channels UPN 220 (Fe E 235)	Box of I-Sections UPN 300 (Fe E 275)
7	Box of channels UPN 180 (Fe E 335)	Box of I-Sections UPN 260 (Fe E 275)
8	Box of channels UPN 240 (Fe E 235)	Box of I-Sections UPN 220 (Fe E 275)
9	Box of channels UPN 260 (Fe E 275)	Box of I-Sections UPN 240 (Fe E 275)
10	Cannel UAP 220 (Fe E 235)	Box of channels UPN 240 (Fe E 235)
11	Cannel UPN 220 (Fe E 275)	Box of channels UPN 220 (Fe E 275)
12	Cannel UAP 300 (Fe E 235)	Box of I-Sections UPN 300 (Fe E 275)
13	Cannel UPN 260 (Fe E 275)	Box of channels UPN 260 (Fe E 235)
14	Cannel UAP 220 (Fe E 355)	Box of I-Sections UPN 240 (Fe E 275)
15	Cannel UPN 300 (Fe E 235)	Box of I-Sections UPN 280 (Fe E 275)

## 2. Task processing.

1. Open and save the file.



Open the file with results of laboratory work № 2 execution and save it with a new name «LW8». This file contains a previously created finite element model of the flat frame with all loadings and restraints applied.

2. Stiffness assignment for frame elements.

To change frame elements stiffness from concrete to steel cross-sections press the button  *Material Properties*. In the dialog box **Stiffness and materials** form a list of stiffness for the current problem. Press the button *Add*, choose tab **Database of steel sections** and set a sectional shape in obedience to the variant.



In the dialog box **Steel cross-section** set the sectional shape for all elements of a cross-section. Select created types of stiffness in a list and press the button **Set as current one**. Select all columns or beams of the frame and press the  *Apply* button. Selection from elements will be removed; it means that the chosen type of stiffness is correctly assigned to elements.

3. Design combination of loadings creation.

Switch to the *Analysis* ribbon and press the  *DCL* button. From the list select building codes – *Eurocode*, set load case types (1st – Dead, 2nd – Live, 3rd – Wind), press **Add** button on the bottom to assign coefficients for a linear combination of loadings and save changes with  *Save data* button.

4. Set of material parameters.



Press on the button  *Material Properties* on the ribbon. In the **Stiffness and Materials** dialog window choose building codes – *Eurocode 3*. In the **Design options** dialog window select analysis of sections by *DCL* and press the  *Apply* button.

In the **Stiffness and Materials** dialog switch to the *Steel* tab, select radio-button *Material* and press the **Add** button. In the dialog window **Parameters** set steel class according to your variant.

Select radio-button *Additional parameters* and press **Add** button. In the dialog window **Parameters**:

- select element type – *Column*;
- set the flag *Use length factors* and set the length factors for Z and Y axes to 1. Repeat this step for beams.



Select radio-button *Selection limitations* and press **Add** button and save default values.

Assign a corresponding set of steel properties to all beams and columns in your model.

#### 5. Structural elements assigning.

Select all finite elements of the design model. Switch to the **Bars** ribbon and press the  *Structural Elements* button. In the dialog window **Structural Elements** press the **Generate StE** button.

#### 6. Fixities setup



Deformation of a horizontal structural element must be calculated in relation to the strict line which goes through its endpoints. To set this line select all horizontal elements of the model and press the  *Deflection Fixities* button on the *Design* ribbon. In the dialog window **Deflection fixities** select *At ends of structural elements* fixities type, set Y1 and Z1 directions and press  *Create* button.

#### 7. Problem calculation.

Switch to the *Analysis* ribbon and press the  *Analyse* button.

#### 8. Cross-sections check and selection results analysis.

Switch to *Design* ribbon. Display  *ULS*,  *SLS* and  *LB* check calculation results.

Display  *ULS*,  *SLS* and  *LB* selection calculation results and compare them to check calculation values.

Press the  *Selected sections* button and compare selected cross-sections to initial ones.

### 3. Control questions.

1. Stiffness assignment for elements.
2. Assigning additional element characteristics to perform a calculation.
3. Structural elements assigning.
4. Check assigned sections.
5. Automatic selection of elements' cross-section.

## Laboratory work № 9. Truss calculation and design

**Aim of work:** familiarize with creation and calculation of truss design models; provide static calculation and selection of cross-sections for a truss structure.

### 1. Task.

Provide a static calculation of truss structure according to variants on 3 load cases – the dead weight, long-term (P) and short-term (q) loadings. Provide select calculation of elements cross-section for truss using DCL.

### 2. Task processing.



1. New problem creation.

Create a new problem with the name «LW9» and elements type «2».

2. Geometry model creation.

Table 9.1 – Given for calculation.

Variant	Truss type	Dimensions	P, kN	q, kN/m	Chord section	Brace section	Steel class
1		L=6 m, Kf=6	8	10	I-section IPN	Angle	Fe E 235
2		L=12 m, Kf=6	12.5	7.5	T-shape IPN	Angle	Fe E 275
3		L=9 m, Kf=7	10	9	Double angle	Angle	Fe E 235
4		L=6 m, Kf=7	7.5	12	Rolled tube	Rolled tube	Fe E 275
5		L=12 m, Kf=7	12	8	Double angle	Angle	Fe E 335
6		L=9 m, Kf=6	8	10	I-section IPN	Angle	Fe E 235
7		L=9 m, K=5, H=3 m, h=1.5 m	10	11	T-shape IPN	Angle	Fe E 335
8		L=6 m, K=3, H=2 m, h=1 m	7.5	10	Double angle	Angle	Fe E 275
9		L=12 m, K=7, h=0.5 m, fi=10°	11	8	Rolled tube	Rolled tube	Fe E 235
10		L=6 m, K=4, H=2.5 m, h=1 m	6	12	Double angle	Angle	Fe E 275
11		L=12 m, K=6, h=1 m, fi=8°	10	8	I-section IPN	Angle	Fe E 335
12		L=9 m, K=6, H=3 m, h=1.5 m	8	10	I-section IPN	Angle	Fe E 275
13		L=12 m, K=10, H=3 m	12	8	Double angle	Angle	Fe E 235
14		L=9 m, K=6, H=1.5 m	8.5	9	I-section IPN	Angle	Fe E 335
15		L=6 m, K=4, H=1 m	7.5	12	Rolled tube	Rolled tube	Fe E 235

Press the  *Create truss* button on the toolbar. In the dialog window **Generate 2D truss** select truss type and set its dimensions according to your variant. Press  *Apply* button and close dialog window.

### 3. Restraints assignment.

Set correct restrains for hinge movable and immovable supports on truss end nodes.



### 4. Stiffness assignment.

Press the button  *Material Properties*. In the dialog window **Stiffness and materials** go to tab *Database of steel sections* and set cross-section shape according to your variant. Select the smallest dimension for each stiffness type and assign them to truss elements.



### 5. Loadings assignment.

Set three load cases on the truss according to your variant.

### 6. Set Design combinations of loads.

Switch to the *Analysis* ribbon and press the  *DCL* button. From the list select building codes – *Eurocode*, set load case types (1st – Dead, 2nd – Live, 3rd – Wind), press **Add** button on the bottom to assign coefficients for linear combination of loadings and save changes with  *Save data* button.

### 7. Material properties assignment.

Press the button  *Material Properties* on the ribbon. In the **Stiffness and Materials** dialog window choose building codes – *Eurocode 3*. In the **Design options** dialog window select analysis of sections by DCL and press  *Apply* button.

In the **Stiffness and Materials** dialog switch to the *Steel* tab, select radio-button *Material* and press the **Add** button. In the dialog window **Parameters** set steel class according to your variant.



Select radio-button *Additional parameters* and press **Add** button. In the dialog window **Parameters**:

- select element type – *Truss*;
- set the flag *Use length factors* and set the length factors for Z and Y axes to 1.

Select radio-button *Selection limitations*, press **Add** button and save default values.

Assign a corresponding set of steel properties to all elements in your model.

### 8. Fixities setup.

Select all horizontal elements of the model and press the  *Deflection Fixities* button on the *Design* ribbon. In the dialog window **Deflection fixities** select *At ends of structural elements* fixities type, set Y1 and Z1 directions and press  *Create* button.

### 9. Provide problem calculation.



Switch to the *Analysis* ribbon and press the  *Analyse* button.

### 10. Results analysis.

To draw the output diagrams of forces and moments in frame elements switch to the *Results* ribbon and press buttons **N**, **Q<sub>z</sub>**, **M<sub>v</sub>**.

11. Cross-sections check and selection results analysis.

Switch to *Design* ribbon. Display  *ULS*,  *SLS* and  *LB* check calculation results.

Display  *ULS*,  *SLS* and  *LB* selection calculation results and compare them to check calculation values.

Press the  *Selected sections* button and compare selected cross-sections to initial ones.

### 3. Control questions.

1. Truss geometry model creation.
2. Design combinations of loads (DCL) calculation.
3. Assigning of additional element characteristics to perform a calculation.
4. Automatic selection of truss elements' cross-section.

## Laboratory work № 10. Combined 3D-model calculation

**Aim of work:** familiarize with creation and calculation of 3D design models; provide static calculation and analysis of a 3D structure.

### 1. Task.

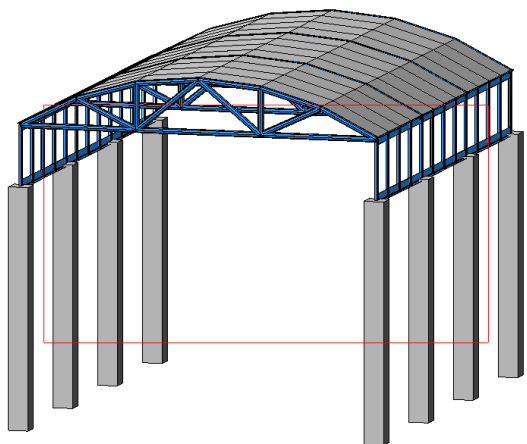

Fig. 10.1 – 3D design model

Provide a static calculation of 3D structure according to variants on 2 load cases: dead weight and snow ( $q$ ).

The thickness of roof plates – 10 cm.



Use stiffness types for a truss that were selected in previous laboratory work.



### 2. Task processing.

1. New problem creation.

Create a new problem with the name «*LW10*» and elements type «5».

2. Geometry model creation.

Press the  *Create truss* button on the ribbon. In the dialog window **Generate 2D truss** select truss type and set its dimensions according to your variant from previous laboratory work. Press  *Apply* button and close dialog window.

Select all nodes and elements of created truss using  *Select block* button. Create  $N$  truss copies with  *Copy* button on the ribbon, go to the first tab **Copy by**







**parameters** and set the number of copies **N** and distance between them **dy**. Press  *Apply* button and close dialog window.

Table 10.1 – Given for calculation

Variant	Span length $L_y$ , m	Span number $N$ , m	Column cross-section, cm	Column height $H$ , m	$q$ , kN/m <sup>2</sup>	Rectangular truss stiffness	
						Chord	Braces
1	3	3	40x60	3	0.8	T-section IPN 200 400	Double angle 0 75 50 7
2	3	5	40x50	7.5	1.0	T-section IPN 250 500	Double angle 0 50 6
3	3	4	40x40	6	0.6	T-section IPN 180 360	Double angle 0 40 25 5
4	4	3	45x40	4	0.8	T-section IPN 200 400	Double angle 0 50 6
5	3	4	45x60	8	0.8	T-section IPN 150 300	Double angle 0 75 50 7
6	3	4	45x45	7	1.0	T-section IPN 200 400	Double angle 0 40 6
7	3	3	45x50	6	1.0	T-section IPN 200 400	Double angle 0 60 40 7
8	3	3	40x50	4	0.8	T-section IPN 150 300	Double angle 0 40 25 5
9	3	5	40x60	7.5	0.8	T-section IPN 180 360	Double angle 0 40 6
10	3	3	40x40	4	1.0	T-section IPN 150 300	Double angle 0 60 40 7
11	4	3	30x30	8	0.6	T-section IPN 250 500	Double angle 0 75 50 7
12	3	4	30x40	6	0.6	T-section IPN 200 400	Double angle 0 40 25 5
13	3	5	30x45	7	1.0	T-section IPN 150 300	Double angle 0 40 6
14	3	4	35x35	5	0.8	T-section IPN 200 400	Double angle 0 50 7
15	3	3	35x45	3	0.8	T-section IPN 180 360	Double angle 0 40 25 5

Press the  *Create truss* button on the ribbon. In dialog window **Generate 2D truss** select rectangular truss type and set its dimensions:  $L = N * L_y$ ,  $K = L$ ,  $H = 1$  m,  $\alpha_z = 90^\circ$ , displacement  $Z = -1$  m. Press  *Apply* button and close dialog window.

Select all nodes and elements of created truss using  *Select block* button. Create truss copy with  *Copy* button on the ribbon, go to the second tab **Copy by one node** and set flag *Specify nodes of copying*. Click on the base node on the truss and after that on the destination node on the other side of construction.

To create roof plate elements select the upper chord of the first truss. Press on the  *Translation of Generatrix* button and set length  $dy = L_y * N$  and the number of finite elements  $n = 4 * dy$ . Press  *Apply* button and close dialog window.

To create columns press  *Create Regular Fragments and Grids* button on the ribbon. In the dialog window **Create plane fragments and grids** go to **Create frame** tab, set column height  $H$  and its displacement  $Z = -H-1$ . Create required column copies with the base node.

Provide model packing with  *Pack Model* button on the ribbon with default settings.

### 3. Restraints assignment.

Set model projection to XOZ plane. Select bottom nodes of all columns and set all restraints on them.

### 4. Stiffness assignment.

Press the button  *Material properties*. In the dialog window **Stiffness and Materials** go to tab **Database of steel sections** and set cross-section shape for both trusses according to your variant. Go to the **Define standard section** tab and create

stiffness type for columns with  $E = 3e7 \text{ kN/m}^2$ ,  $R_o = 25 \text{ kN/m}^3$ . Go to third tab **Plates, solids, numerical** and create stiffness for plate elements with  $E = 3e7 \text{ kN/m}^2$ ,  $V = 0.2$ ,  $R_o = 25 \text{ kN/m}^3$ .



Use  *Fragmentation* and *Projection on XOZ, XOY, YOZ plane* commands on the bottom toolbar for element selection. Assign created stiffness types to respective elements.

5. Loadings assignment.

Assign 2 load cases on the design model according to your variant.

6. Provide problem calculation.

7. Results analysis.

Switch to *Results* ribbon and draw the output  *Displacement contour plot* on Z axis and  *Stress contour plot* for  $Q_x$ ,  $Q_y$  for roof plane elements. Select and fragment all columns and draw diagrams of bending moments in them.

Save the file.

Execute main menu command *3D Model*. Press the  *Show Real Sections* button on the ribbon.

### 3. Control questions.

1. 3D models geometry model creation.
2. Stiffness assignment for elements of a model.
3. Model fragmentation.
4. Results analysis for 3D models.
5. 3D model view.

## Laboratory work № 11. Frame dynamic calculation

**Aim of work:** familiarize with dynamic loadings assignment and calculation; provide flat frame calculation on pulsating wind and earthquake loadings.

### 1. Task.

Use a flat frame from laboratory work № 2. Provide dynamic calculation on pulsating wind and earthquake loadings using DCL.

Table 11.1 – Given for calculation.

Variant	Wind region	Site type	Subsoil class G	Acceleration, $\text{m/s}^2$
1, 4, 7, 10, 13	2	B	1	1.38
2, 5, 8, 11, 14	3	C	3	0.85
3, 6, 9, 12, 15	4	A	2	2.4

### 2. Task processing.

1. New problem creation.

Open the file with laboratory work № 2 results and save it as a new file with the name «LW11».

## 2. Account of static load cases.

On the *Analysis* ribbon click the  *Account of Static Load Cases* button. In **Create dynamic load cases from the static ones** dialog window set the following settings:

- For pulsating wind loading:
  - Dynamic load case No. – 4;
  - No. of corresponding static load case – 1;
  - Conversion factor –1.

Press  *Add* button. Repeat operation for static load case No. 2.

- For earthquake loading:
  - Dynamic load case No. – 5;
  - No. of corresponding static load case – 1;
  - Conversion factor – 1.

Press  *Add* button. Repeat operation for static load case No. 2.

## 3. Dynamic loadings assignment.

On the *Analysis* ribbon click the  *Table of Dynamic Load Cases* button. In the **Table of dynamic load cases** dialog window enter the following settings:

- For pulsating wind loading:
  - Parameter row № – 1;
  - Load case No. – 4;
  - Dynamic load case No. – *Pulsation (21)*;
  - Number of analysed mode shapes – 3;
  - No. of corresponding static load case – 3.

Press the **Parameters** button and set additional parameters according to your variant: wind region, frame dimensions, site type and wind direction – 1 (along X axis).

Press  *OK* button.

- For earthquake loading:
  - Parameter row № – 2;
  - Load case No. – 5;
  - Dynamic load case No. – *Earthquake (EN 1998-1:2004) – (44)*;
  - Number of analysed mode shapes – 6.

Press the **Parameters** button and set additional parameters according to your variant: subsoil category, acceleration, earthquake direction (CX=1), additional factors set equal to 1. Press  *OK* button.

## 4. DCL calculation.



On the *Analysis* ribbon press the  *DCL* button. Select *EUROCODES* and assign types for all load cases:

- Load case 1 – *Dead*;

- Load case 2 – *Live*;
- Load case 3 – *Inactive*;
- Load case 4 – *Wind*;
- Load case 5 – *Earthquake*.

Press **Add** and  *Save data* buttons and close dialog.

5. Provide problem calculation.
6. Results analysis.

Switch to *Results* ribbon and display mode shapes for dynamic load cases No. 4 & 5 by  *Mode shapes* button on the bottom toolbar. Show animated mode shapes with main menu command *3D Model* and  *Animate Mode Shapes* ribbon button.

Display *Periods of vibrations* and *Mode shapes* tables with dynamic loadings analysis using  *Documents* button for all load cases.

### 3. Control questions.

1. Account of static load cases during dynamic calculations.
2. Types of dynamic loadings.
3. Dynamic loadings assignment.
4. Additional parameters for earthquake loadings.
5. Additional parameters for pulsating wind loadings.
6. Mode shapes animation.
7. Structure periods of vibrations.

## Laboratory work № 12. Calculation and design of a steel tower

**Aim of work:** repeat general order of steel constructions design; provide calculation and design of steel tower with pulsing wind loading.

### 1. Task.

Create geometry model of steel tower (fig. 12.1) and provide calculation on 5 load cases and DCL: dead weight, icing ( $q_o$ ), equipment weight ( $q_p$ ) and wind ( $q_w$ ) with dynamic pulsing (table 12.1).

Provide select calculation of steel elements cross-section taking into account construction elements. Repeat model calculation with new selected stiffness types. Find loading on fundament.

### 2. Task processing.

1. New problem creation.

Create a new problem with the name «*LW12*» and model type «4».

2. Geometry model creation.

Press  *Add Node* button on the ribbon and set coordinates for the bottom ( $L/2$ ;  $L/2$ ; 0) and upper ( $l/2$ ;  $l/2$ ;  $N \times h$ ) nodes of one of the stands. In the dialog window **Add**



**Node** go to *Divide into N equal parts* tab, set flags *Specify nodes with pointer* and *Join nodes with bars*. Enter N value according to your variant and draw stand elements between previously created nodes.

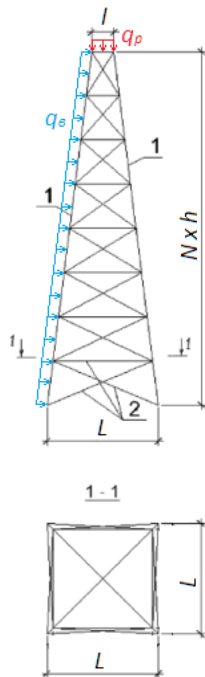

Figure 12.1 – Tower design model

Select all created finite elements and press the *Copy* button on the ribbon. Go to the *Mirror copy* tab, select YOZ plane and press *Apply* button.

On the toolbar, press the *Add Element* button and connect corresponding nodes of stands to create brace elements.

3. Restraints assignment.

Select bottom nodes of stands and set X, Y, Z restraints on them.

4. Stiffness assignment.

Press the button *Material Properties*. In the dialog window **Stiffness and materials** go to tab **Database of steel sections** and set cross-section shape according to your variant. Assign created stiffness types to tower stands and braces.



5. Geometry model editing.

Select all created finite elements and press the *Copy* button on the ribbon. Go to the *Copy by rotation* tab, select Z as a rotation axis, enter rotation angle 90°, number of copies 3 and press *Apply* button.

Provide model packing with *Pack Model* button on the ribbon with default settings.



Table 12.1 – Given for calculation.

Variant	L, m	l, m	N x h, m	q <sub>0</sub> , kN/m	q <sub>w</sub> , kN/m	q <sub>p</sub> , kN/m	Wind region	Stand cross-section	Brace cross-section
1	5	1.0	8 x 2	2.5	1.0	2.5	2	Rolled tube	Rolled tube
2	5	1.5	6 x 2	2.0	1.0	3.0	3	Box of channels	Angle
3	4	1.5	5 x 2	2.0	0.8	3.0	5	Channel	Angle
4	4.5	1.0	6 x 2	2.5	0.6	2.0	4	Box of channels	Channel
5	4.5	1.0	7 x 2	2.0	1.0	2.5	3	Angle	Channel
6	5	1.0	8 x 2	2.0	0.9	2.7	2	Rolled tube	Rolled tube
7	5	1.5	6 x 2	2.5	1.0	2.8	3	Box of channels	Angle
8	4	1.5	5 x 2	1.8	1.1	2.5	1	Rolled tube	Rolled tube
9	4.5	1.0	6 x 2	2.3	0.7	2.0	4	Box of channels	Angle
10	4.5	1.0	7 x 2	2.3	1.0	2.3	2	Box of channels	Channel
11	5	1.0	8 x 2	2.0	0.9	2.5	3	Angle	Channel
12	5	1.5	6 x 2	1.8	1.0	3.0	2	Box of channels	Angle
13	4	1.5	5 x 2	2.0	0.8	2.7	4	Rolled tube	Rolled tube
14	4.5	1.0	6 x 2	2.5	0.6	2.3	5	Box of channels	Channel
15	4.5	1.0	7 x 2	2.0	1.1	2.5	3	Angle	Angle

Press  *PolyFilter* button on the bottom toolbar and go to *Section and cut off*. Set *Arbitrary* plane, select any 3 nodes on the opposite stands of a tower and press  *Apply* button. All elements located in the specified plane will be selected. Use model fragmentation and projections on coordinate planes to create internal braces of the tower. Assign stiffness type to them. Repeat internal braces creation for the other two opposite stands of the tower.

#### 6. Loadings assignment.

Assign the first 4 static loadings on the tower design model according to your variant.

Create wind pulsation load case using  *Account of Static Load Cases* and  *Table of Dynamic Load Cases* on the *Analysis* ribbon.

#### 7. Assignment of additional parameters.



Press the  *Material properties* button. In the dialog window **Stiffness and materials** set the *Material* flag and select building codes for design – *Eurocode 3.1.1*, set analysis of sections by DCL. Switch to the *Steel* tab in the lower part of the **Stiffness and materials** dialog, select the *Material* radio button and press **Add...** button. Set steel class *Fe 355* for all elements.

Select *Additional parameters* radio button, press **Add...** button and



- select *Truss* element type;
- set the flag *Use length factors*;
- set the length factors  $K_Z$  and  $K_Y$  to 1.

Assign created material properties to all elements of a model.

#### 8. Calculation of Design combinations of loads.

Switch to *Analysis* tab and press  *DCL* button. Assign types for all load cases (1 – Dead, 2 – Snow, 3 – Live, 4 – Inactive, 5 – Wind) and press **Add** and  *Save data* buttons.

#### 9. Assign elements unification group.

Select all stand elements of the model. To select same cross-section for all of them press  *Unify Elements* button on the ribbon and press  *Create new UG* button.

#### 10. Provide problem calculation.

#### 11. Results analysis.

For wind pulsation load case display inertia forces with *Inertial Forces* buttons on the *Advanced Results* ribbon. Switch to *Results* ribbon and display  *Mosaic Plot of Acceleration a*.

To find values of loading on fundament select bottom nodes of all stands and adjacent elements and press  *Calculate Load* button on the *Advanced Results* ribbon. In dialog window **Analysis of loads on fragment** press **Refresh** button and run calculation by **Analyse** button. To display results press  $\Sigma P_x$ ,  $\Sigma P_y$ ,  $\Sigma P_z$  buttons on the

*Advanced Results* ribbon and show numeric values with  *Flags of Drawing* button on the bottom toolbar.

### **3. Control questions.**

1. Main steps of steel constructions design and calculation.
2. Copy options for 3D-model geometry creation.
3. Assigning of dynamic loadings on model elements.
4. Additional properties for steel cross-section selection calculation.
5. Calculation of loading on fundament.

## **Laboratory work № 13. Base slab calculation with foundation bed**

**Aim of work:** familiarize with methods of consideration of real foundation bed during base elements calculation; provide base slab calculation with foundation bed.

### **1. Task.**

Provide base slab calculation in join with foundation bed using design model from laboratory work № 7. Use 2 types of bed models: modules of subgrade reactions and finite stiffening braces (springs).

### **2. Task processing.**

#### ***A. Base slab with one module of subgrade reactions (Winkler model)***



1. New problem creation.

Open the file with laboratory work № 7 results and save it as a new file «*LW13-1*».

2. Restraints assignment.

Select all nodes of the design model, press the  *Restraints* button and remove all restraints from a model.

3. Assigning parameters of foundation bed.

Select all elements of a model and press the  *Moduli of Subgrade Reaction* button on the ribbon. In the dialog window **Define moduli C1 and C2** select *Plates* elements' type, set  $C1 = 10000 \text{ kN/m}^3$  and press  *Apply* button.

4. Provide problem calculation.

5. Results analysis.

Draw on the screen  *Displacement Contour Plots*,  *Stress Contour Plots*.

#### ***B. Base slab with finite stiffening braces.***



6. New problem creation.



Open the file with laboratory work № 7 results and save it as a new file «*LW13-2*».

7. Restraints assignment.

Select all nodes of the design model, press the  *Restraints* button and remove all restraints from a model.

8. Assigning of finite stiffening braces (spring elements).

Select all nodes of the design model and press  *Add Element* button on the ribbon. Go to *Add One-Node FE* tab, select finite element's type *51* and press  *Apply* button.



Press the button  *Material Properties*. In the dialog box **Stiffness and Materials** press the button *Add>>*, choose tab *Plates, solids, numerical* and select *Numerical for FE 51*. In the dialog box **Numerical Description for FE 51** enter the parameters: the modulus of rigidity  $R = 2500$  kN/m, direction – Z and press  *OK* button.

In the dialog box **Stiffness and Materials** select the row «*Numerical for FE 51*» and press the *Copy* button twice. Edit copied stiffness types and set them  $R = 1250$  kN/m and  $R = 625$  kN/m values.

Select all internal one-node finite elements (springs) and assign them stiffness type with  $R = 2500$  kN/m. Assign stiffness type with  $R = 1250$  kN/m to all external one-node finite elements on the perimeter of a slab and with  $R = 625$  kN/m – to 4 one-node finite elements on the corners of a slab.

9. Provide problem calculation.

10. Results analysis.

Display on the screen  *Displacement Contour Plots*,  *Stress Contour Plots*, **R<sub>z</sub>** *Forces in 1-node FE*. Compare these results with results received in part A.

### 3. Control questions.

1. Methods of consideration of real foundation bed during base elements calculation.

2. Winkler model.

3. Assigning parameters of foundation bed.

4. Assigning of finite stiffening braces (spring elements).

5. Results analysis of plate calculation.

## Laboratory work № 14. Construction calculation with 3D soil modelling

**Aim of work:** familiarize with methods of consideration of real foundation bed during base elements calculation; provide construction calculation in join with multi-layer 3D soil model using a rigid body.

### 1. Task.

Provide calculation of concrete construction with multi-layer soil model. Floor height  $H$ , the distance between columns  $L_X \times L_Y$  (fig. 14.1) according to variants (table 14.1). Provide calculation on three load cases: 1) dead weight; 2) vertical loadings  $P$ ,  $q_1$  (on foundation slab),  $q_2$  (on floor slab); 3) horizontal loading  $F$ . Column

shape – rectangular 80x40 cm, foundation slab thickness  $\delta_1$ , floor slab thickness  $\delta_2$ . Recommended FE size – 0.2 m.

## 2. Task processing.

1. Creation of a new problem.

Create a new file. In the dialog box **Model type** set the problem name «LW14» and elements type «5».

2. Geometrical model creation.

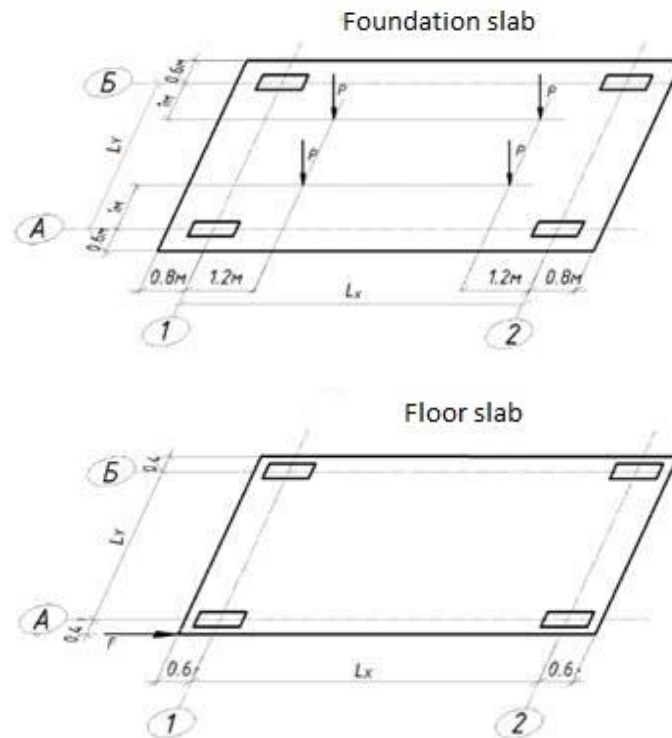





Figure 14.1 – Loading scheme and element dimensions

Table 14.1 – Given for calculation



Variant	$L_x$ , m	$L_y$ , m	H, m	$\delta_1$ , cm	$\delta_2$ , cm	P, kN	F, kN	$q_1$ , kN/m <sup>2</sup>	$q_2$ , kN/m <sup>2</sup>	$P_z$ , kN/m <sup>2</sup>
1	6.0	4.0	3.0	50	15	1000	20	10	5	120
2	5.0	4.5	2.7	45	10	800	30	15	3	140
3	5.5	4.5	2.8	45	12	750	25	13	5	130
4	7.0	5.0	3.0	60	15	850	15	7	3	120
5	6.5	4.5	3.0	50	15	800	15	8	5	100
6	5.0	4.0	2.7	40	10	900	25	15	7	120
7	5.5	4.0	2.8	45	10	1000	25	13	5	140
8	6.0	4.5	3.0	50	12	850	20	8	3	130
9	7.0	5.0	2.9	60	15	750	15	7	3	110
10	6.5	5.0	3.0	60	12	800	20	9	5	120
11	6.0	5.0	2.8	55	10	800	25	9	7	100
12	5.0	4.5	2.8	45	10	900	30	12	5	140
13	5.5	4.0	3.0	45	12	850	30	12	7	130
14	6.5	4.5	3.0	60	15	1000	25	10	3	120
15	6.0	4.0	2.8	45	12	850	20	10	5	110

On the ribbon, press the button  *Create Regular Fragments and Grids*. On the tab *Create slab* set the step of finite elements (FE) – 0.2 m – and amount of steps along X and Y axes. Press the  *Apply* button.

Repeat FE creation for floor slab, set coordinates for corner node (0.2; 0.2; H), press the  *Apply* button and close a dialog box.

On the ribbon press  *Add Element* button, switch to *Add bar* tab and connect corresponding slab nodes to create column elements.

### 3. Creation of rigid bodies.

On the ribbon press  *Perfectly Rigid Body* button. Select nodes of column contour on fundament slab, in the **Perfectly rigid body** dialog window set *Specify principal node* flag and select the central node of the column. Press the  *Add* button and repeat rigid body creation steps for all columns in fundament and floor slab planes.

### 4. Restraints assignment.



Select all nodes of the fundament slab except those which belongs to perfectly rigid bodies. Set for them restraints along X, Y axes.

### 5. Stiffness assignment.



Press the button  *Material Properties*. In the dialog window **Stiffness and materials** press **Add>>** button, choose tab *Plates, solids, numerical* and select *Plates*. In the dialog box **Stiffness for plates** enter the parameters: modulus of rigidity  $E = 3e7$  kN/m<sup>2</sup>, Poisson's ratio  $\nu = 0.2$ ,  $R_0 = 25$  kN/m<sup>2</sup> and slab thickness. Set this stiffness type as current and assign it to all slab's FE. Repeat slab stiffness assignment for the floor slab.

Switch to the *Standard types of sections* tab, create stiffness for columns as *Bar* according to your variant and assign it to column elements.

### 6. Soil model creation.

Select all elements of fundament slab and press the  *Moduli of Subgrade Reaction C1, C2* button on the ribbon. In the **Define moduli C1 and C2** dialog window set *Plates* flag, select *From soil model* option and assign distributed loading on slab  $P_z$ . Press  *Apply* button.

In the **Define moduli C1 and C2** dialog window press the **Soil model** button. In the **Soil model** dialog window set *Coefficient for depth of compressible stratum* – 0.2, calculation method – *Method 3*, building code *DBN B.2.1-10:2009* and press **Attach soil model** button.



A new window with a soil model will be opened. Press  *Edit Grids* button on the toolbar and set parameters: the first point coordinates X=-1 m, Y=-1 m; FE step – 1 m; the number of steps along axis X – 20, Y – 15. Press  *Apply* button.



Press  *Edit Boreholes* button on the toolbar and set parameters for three boreholes:



1)  $X=0.8*L_X$ ,  $Y=2*L_Y$ ; soil layer types and depth of layer: № 1 –  $0.5*L_X$ , № 2 –  $L_X$ , № 5 – 15 m;

2)  $X=1.5*L_X$ ,  $Y=0.75*L_Y$ ; layers № 1 –  $0.25*L_X$ , № 2 –  $1.3*L_X$ , № 5 – 15 m;

3)  $X=0.5*L_X$ ,  $Y=0.5*L_Y$ ; layers № 1 –  $0.3*L_X$ , № 2 –  $1.1*L_X$ , № 5 – 15 m.

After each step press  *Refresh table* button. Press the  *Apply* button to save a table.

To assign loadings on a substrate from nearby standing buildings press the  *Edit loads* button on the toolbar. In the **Loads** dialog window set parameters  $X=13$  m,  $Y=9$  m;  $dX=4$  m,  $dY=5$  m; loading value  $200 \text{ kN/m}^2$ ; elevation – 97 m. Press the  *Apply* button.

To import loadings on fundament bed from main design model press  *Edit imported loads* button, set elevation 96 m and press  *Apply* button.

Save created soil model and switch to the main design model.



7. Loading assignment.



Assign 3 load cases on model according to your variant: dead weight; vertical  $P$ ,  $q_1$ ,  $q_2$ ; horizontal  $F$ .

8. Problem calculation.

Press  *Analyse* button on the *Analysis* ribbon and confirm assigned soil model calculation.

9. Calculation results analysis.

Switch to *Results* ribbon and display on the screen  *Displacement Contour Plots* and  *Stress Contour Plots* for both slabs. Switch to *Advanced results* ribbon and display  *Contour Plot for Moduli of Subgrade Reaction* for a fundament slab.

Switch to soil model. On the toolbar press  *Modified calculation for Pasternak model* button. Press  *Borehole at Arbitrary Point* button and click at any point of soil model to show extrapolated layers there.

Press  *Arbitrary Soil Profile* and  *Specify points on plan* buttons to show soil model on set section plane.

Switch to *Settlement*,  $C_1$ ,  $C_2$  tabs. Execute *Window => Table Organizer => Create Tables* menu command and export boreholes and soil parameters.

### 3. Control questions.

1. Design model creation of two-dimensional elements.
2. Perfectly rigid bodies creation.
3. Soil model creation.
4. Soil model calculation results analysis.
5. Main types of soil models.

## Laboratory work № 15. Calculation and design of industrial building frame

**Aim of work:** repeat order of design model creation and analysis; provide calculation of industrial building frame with subgrade and selection of steel and RC elements.

### 1. Task.

Provide calculation of flat frame with subgrade modelling (fig. 15.1) with DCL and check the stability of elements. Provide concrete elements reinforcing and steel elements cross-section selection according to variant (table 15.1).

Take into account 5 load cases: 1) dead weight; 2) equipment loading  $q$  and environment loading  $P$ ; 3) static wind loading  $F$ ; 4) dynamic harmonic load  $A$ ,  $\omega$ ; 5) seismic.

The cross-section shape of the base beam is T-section.

### 2. Task processing.

1. Creation of a new problem.

Create a new file. In the dialog box **Model type** set the problem name «LW15» and model type «2».

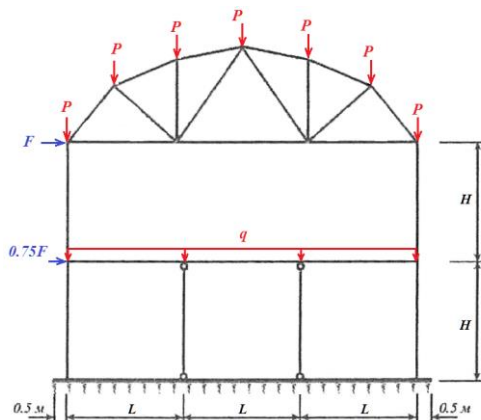

Figure 15.1 – Loading scheme and frame dimensions.

2. Geometrical model creation

Using commands **Create Regular Fragments and Grids**, **Create truss**, **Add Element** create geometrical model according to your variant.

Click on **Information about Nodes and Elements** button on the toolbar and click on internal columns. In the dialog window **Element** go to the **Hinges** tab and set flags for both elements' nodes on  $UY$  with zero rigidity.

Select horizontal elements. On the **Bars** ribbon click on **Design Sections of Bars** button and set the number of design sections  $N = 5$ .

Provide model packing.

3. Restraints assignment.

Select all nodes of the base beam and assign them restraint on the X axis.

4. Assigning parameters of foundation bed.

Select all elements of the base beam and click on the **Moduli of Subgrade Reaction C1, C2** button on the ribbon. In the dialog window **Define moduli C1 and C2** select **Bar** element's type, set  $C1z$  according to your variant and press **Apply** button.



Table 15.1 – Given for calculation.

Variant	L, m	H, m	Base beam	External columns	Internal columns	Beam	Truss	P, kN	q, kN/m	F, kN	A, kN	$\omega$ , rad/s	Steel
1	4.0	4.0	B=40, H=60, B1=100, H1=20 cm	Box of channels UPN 240	Channel UPN 220	I-section IPN 300	Double angle 1 100 10	20	8	20	1	15.7	Fe E 235
2	5.0	4.5						30	5	15	1.5	6.5	Fe E 275
3	5.0	4.0						25	6	20	0.1	156	Fe E 235
4	4.5	3.0	C1=10 MN/m <sup>3</sup>	I-section IPN 400	I-section IPN 200	Box of channels UPN 200	T-section IPN 120 240	35	5	18	2.5	1.2	Fe E 335
5	4.0	3.5						25	3	10	0.5	37	Fe E 235
6	5.0	3.5						30	4	15	0.8	25	Fe E 275
7	4.0	4.0	B=60, H=80, B1=120, H1=40 cm	Box of I- sections IPN 300	T-section IPN 100 200	T-section IPN 200 400	Double angle 0 80 10	20	5	20	0.2	78	Fe E 235
8	4.5	3.0						15	3	10	0.3	56	Fe E 275
9	5.0	4.0						25	6	12	0.7	65	Fe E 235
10	4.0	3.0	C1=8 MN/m <sup>3</sup>	Box of channels UPN 280	I-section IPN 240	Box of channels UPN 300	Angle 0 120 13	40	4	8	0.5	42	Fe E 335
11	4.5	3.5						30	8	15	0.8	30	Fe E 235
12	4.5	4.0						25	6	20	0.2	100	Fe E 335
13	4.0	3.5	H1=30 cm	I-section IPN 260	Channel UPN 240	I-section IPN 300	Double angle 0 70 9	35	5	12	1	21.7	Fe E 235
14	5.0	4.0						20	3	10	0.8	30	Fe E 275
15	4.5	4.0						30	4	15	0.3	65	Fe E 335



### 5. Stiffness assignment.



On ribbon press button  *Material Properties*. In the dialog window **Stiffness and Materials** create all needed stiffness types and assign them to model elements. For concrete stiffness types use  $E = 3e7$  kN/m<sup>2</sup>,  $R_o = 27.5$  kN/m<sup>3</sup>.

Assign material properties for reinforced concrete and steel stiffness types, add fixities and structural elements.

### 6. Loadings assignment.

Create 5 load cases according to your variant: dead weight; exlpuatational  $P$ ,  $q$ ; static wind loading  $F$ ; dynamic harmonic load with amplitude  $A$  and angular frequency  $\omega$ ; seismic with  $0.141$  m/s<sup>2</sup> acceleration.



For harmonic load case select the upper node of one of the internal columns and press the button  *Loads* on the ribbon. In the dialog box **Define loads** go to the tab *Loads on Nodes*, press  *Nodal harmonic load* button and set its parameters: additional mass 30 kN, magnitude  $A$  and load direction X.

To create dynamic loadings press the  *Account of Static Load Cases* button on the *Analysis* ribbon. In the **Create dynamic load cases from the static ones** dialog window collect mass to nodes from 1st and 2nd load cases. Press the  *Table of Dynamic Load Cases* button. In the **Table of Dynamic Load Cases** dialog window enter the following settings: for harmonic loading – *Zonal harmonic (28)*; for seismic one – *Earthquake (EN 1998-1:2004) (44)* and set additional parameters.

### 7. DCL calculation.



Switch to the *Analysis* ribbon and press  *DCL* button. Assign types for all load cases:

- Load case 1 – *Dead*;
  - Load case 2 – *Live*;
  - Load case 3 – *Wind*;
  - Load case 4 – *Accidental*;
  - Load case 5 – *Earthquake*.
8. Element stability calculation.

On the *Analysis* ribbon press  *Stability* button, set calculation by DCL and press  *OK* button.

9. Provide problem calculation.
10. Results analysis.

Switch to *Results* ribbon and display displacement along *Z* axis, *Q*, *N*, *M<sub>y</sub>* diagrams. On *Design* ribbon display reinforcement and steel calculation results.

To draw a buckling shape switch to the *Advanced results* ribbon and press the  *Buckling Mode* button on the bottom toolbar. Display effective length calculation results by pressing  *Ly Factors* button. Save *Periods of vibrations* and *Stability factors* tables.

### 3. Control questions.

1. Stiffness assignment for elements.
2. Design combination of loads calculation.
3. Assigning parameters of foundation bed.
4. Assigning of harmonic loadings.
5. Element stability calculation.
6. Automatic selection of steel elements cross-section.
7. General order of reinforced concrete elements design.

## Laboratory work № 16. Cabling truss calculation

**Aim of work:** provide cabling truss calculation with prestressed elements.

### 1. Task.

Provide cabling truss calculation with prestressed elements according to variants (table 16.1). Truss chords are made with flexible steel ropes with diameter *D*. Prestress is created with jack with length 0.5 m. Provide calculation on 3 load cases: dead weight, pretension *F*, live loading *P<sub>1</sub>*, *P<sub>2</sub>*.

### 2. Task processing.

1. New problem creation.





On the main toolbar press the button  *New*. In the dialog box **Model type** set the problem name «LW16» and model type «2».

Table 16.1 – Given for calculation.



Variant	Model drawing	l, m	h, m	P <sub>1</sub> , kN	P <sub>2</sub> , kN	D, mm	F, kN	Braces cross-section
1		3	1	20	40	19	600	Channel UPN 100
2		2	0.75	15	30	20	500	Angle 0 60 8
3		2.5	1	20	30	18	550	Angle 0 50 40 65
4		3	1	20	35	22	550	Angle 0 50 7
5		2	0.75	15	25	15	450	Pipe D48.3x2.9
6		2.5	1	20	30	18	600	Channel UPN 80
7		3	1	20	35	20	700	Pipe D60.3x2.9
8		2	0.75	15	25	16	500	Angle 0 40 6
9		2.5	1	20	30	17	600	Angle 0 50 40 6
10		3	2	20	40	22	700	Channel UPN 120
11		2	1	15	30	17	550	Pipe D42.4x2.6
12		2.5	1.5	25	35	19	600	Angle 0 65 50 5
13		3	2	20	40	21	700	Angle 0 50 8
14		2	1.5	15	30	18	600	Pipe D48.3x2.9
15		2.5	2	25	35	20	650	Channel UPN 80

## 2. Geometrical model creation.

On the ribbon press the  *Create Regular Fragments and Grids* button. Switch to the *Create Cartesian grid* tab and set the XOZ plane, grid step and number of steps according to your variant. Press  *Apply* button and close a dialog box.

On the ribbon press  *Add Element* button, uncheck *Consider intermediate nodes* and connect nodes of a grid according to your variant.



Copy right node of a model and create additional element for jack. Pack the model.

Select brace elements and set hinges on their ends. To do that press the  *Information about Nodes and Elements* button on the bottom toolbar and click on brace element. In dialog window **Bar** switch to  *Hinges* tab and set flags for both elements' nodes on UY with zero rigidity. Press  *Apply* button and close a dialog box.

## 3. Restraints assignment.

Assign restraints to nodes according to your variant schema.

## 4. Changing type of finite elements.

Select jack element and press  *Change FE Type* button on the *Advanced edit options* tab. Select 308 – *Geometrically nonlinear special 2-node for simulation of pretension* type and press  *Apply* button.

Select truss cords and set them 310 – *Geometrically nonlinear arbitrary 3D bar (cable)* FE type.



## 5. Stiffness assignment.

On the ribbon press the button  *Material Properties*. In dialog window **Stiffness and Materials** go to tab *Database of steel sections* and set braces cross-section shape according to your variant.

Go to *Plates, solids, numerical* tab and set *FE 310 (cable)* stiffness type for chords with parameters:  $E = 2.1e8 \text{ kN/m}^2$ ;  $D$  – according your variant;  $d = 0$ ;  $R_o = 78.5 \text{ kN/m}^3$ .



6. Loadings assignment.

On the ribbon press the  *Add Dead Weight* button and confirm dialog with default options.

Switch to the next load case, select jack element and press  *Loads* button on the ribbon. Go to *Loads on bars* tab, click on pretension loading type  and set its value  $F$ .

Switch to the next load case and set vertical loadings on truss nodes.

7. Modelling nonlinear load cases.

On the *Analysis* ribbon press the  *Step-type Method* button. In dialog window **Model nonlinear load cases of the structure** press  *Add* button to create new load history. After that set load case number (1) and analysis method (4) *Assign step automatically*. Repeat same steps for load cases 2 and 3. Press  *Apply* button.

8. Provide problem calculation.

9. Results analyzing.

Switch to *Results* ribbon and display displacements mosaic plots for nodes and diagrams of internal forces for model elements. Press  *Documents* button and save displacements table.

**3. Control questions.**

1. Geometrically nonlinear finite elements.
2. Hinges assignment.
3. Pretension modelling in cable elements.
4. History of load cases for nonlinear calculations.

## **Laboratory work № 17. Nonlinear calculation of the beam taking into account the creep of concrete**

**Aim of work:** learn the method of specifying the characteristics of the physical nonlinearity of materials, taking into account the creep of concrete; carry out modeling of nonlinear loads of a beam.

### **1. Task.**



Create a model of a two-span beam (fig. 17.1) and calculate it for a dead weight loading and distributed load ( $q_1, q_2, q_3$ ) according to the variant (table 17.1). Set the characteristics of physical nonlinearity of concrete and create a table for modelling nonlinear loads. Analyse the state of the calculation scheme after 365 and 730 days of operation.

### **2. Task processing.**

1. New problem creation.

On the main toolbar press the button  *New*. In the dialog box **Model type** set the problem name «LW17» and model type «2».

2. Geometrical model creation.

On the ribbon press the  *Create Regular Fragments and Grids* button. On the tab **Create frame** set the step of finite elements and number of steps along horizontal and vertical axes. Divide each span of the beam into 4 FEs of equal length. Press the button  *Apply* and close a dialog box.

3. Restraints assignment.

For a central support set restraints along X, Z axes, for supports on the both ends of a beam – along Z.

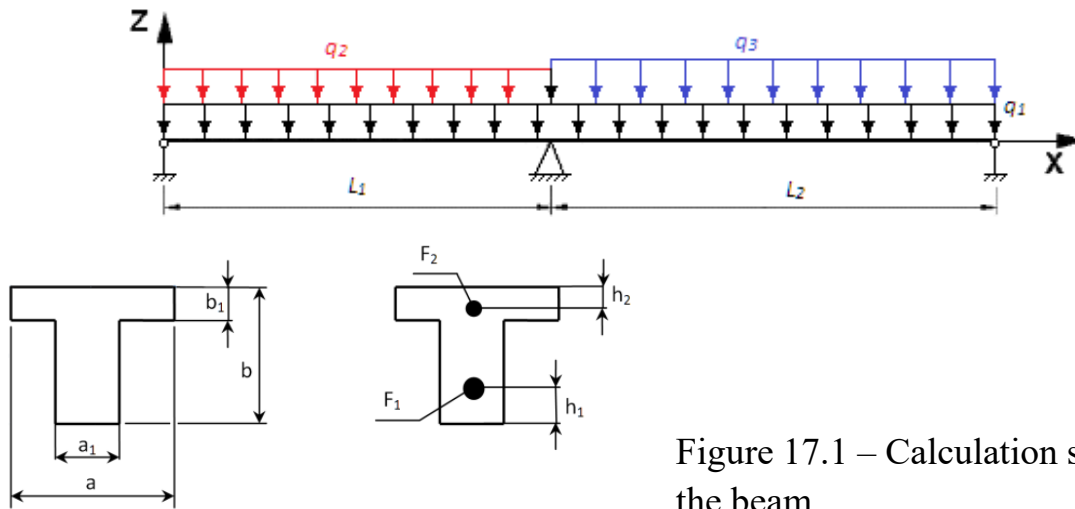



Figure 17.1 – Calculation scheme of the beam

Table 17.1 – Given for calculation

Variant	L <sub>1</sub> , m	L <sub>2</sub> , m	a, cm	a <sub>1</sub> , cm	b, cm	b <sub>1</sub> , cm	F <sub>1</sub> , cm <sup>2</sup>	h <sub>1</sub> , cm	F <sub>2</sub> , cm <sup>2</sup>	h <sub>2</sub> , cm	q <sub>1</sub> , kN/m	q <sub>2</sub> , kN/m	q <sub>3</sub> , kN/m	Conc-reate name	Conc-reate type
1	5.4	6.2	70	30	60	20	6.0	6	1.5	6	3	9.0	8.7	B15	HA
2	5.0	6.0	60	20	60	25	8.0	5	2.0	7	4	8.5	9.0	B25	HB
3	6.2	5.4	60	30	50	20	7.5	4	2.5	5	3.5	7.5	8.0	B30	HC
4	4.8	6.2	70	20	60	25	7.0	5	3.0	6	3	8.7	7.8	B20	MA
5	5.6	4.8	60	20	50	20	6.5	4	1.5	4	3.25	8.2	9.0	B35	MB
6	5.8	5.0	70	30	55	25	7.5	4.5	3.0	6	4	7.5	7.8	B25	MA
7	6.0	5.2	70	20	60	20	8.5	7	2.0	5	3.75	7.0	8.0	B20	HA
8	5.2	5.4	60	20	55	20	8.0	6	2.5	5	3.5	7.2	8.2	B30	HB
9	4.8	5.6	70	25	65	25	9.0	8	3.0	7	3	9.0	8.5	B55	HC
10	6.0	4.8	60	30	65	20	7.5	7	2.8	6	3.25	7.8	8.7	B40	MB
11	5.6	5.4	60	25	50	20	7.2	4	2.3	4	3.5	8.2	8.0	B25	HB
12	5.0	5.0	70	30	60	25	6.8	5	2.5	5	3	8.5	8.0	B35	MA
13	5.4	5.6	60	20	55	20	6.5	4.5	1.8	6	3.25	8.2	7.8	B20	MB
14	5.8	6.0	70	20	60	25	7.0	5	2.8	7	4	8.0	7.0	B30	HB
15	5.2	5.6	70	25	60	20	6.8	6	3.0	5	3.75	8.5	8.0	B40	HC

#### 4. Changing type of finite elements.

Select all elements and press  *Change FE Type* button on the *Advanced edit options* tab. Select FE type *210 – physically nonlinear arbitrary 3D bar* from the list and press  *Apply* button.

5. Stiffness assignment taking into account physical nonlinear properties of the material.

Press the button  *Material Properties*. In the dialog box **Stiffness and materials** press the button *Add>>*, choose tab **Standard types of sections**, select a *T-section* and assign its dimensions in obedience to the variant and  $R_o = 27 \text{ kN/m}^3$ . Set checkbox *Nonlinear parameters* and press button **Material parameters**.

In the dialog window **Nonlinear stress-strain diagrams for materials** select diagram type *25 – exponential* and assign concrete class and type. Set checkboxes *Account of reinforcement* and *Account of creep in concrete*. Go to tab *Reinforcement*, select type of diagram *11 – exponential* and set following parameters:

- modulus of rigidity  $E_o(-) = 2e8 \text{ kN/m}^2$ ;  $E_o(+) = 2e8 \text{ kN/m}^2$ ;
- yield stress  $\sigma(-) = -3e5 \text{ kN/m}^2$ ;  $\sigma(+) = 3e5 \text{ kN/m}^2$ .

Switch to tab *Creep in concrete*, select creep diagram *41 – exponential for creep* and set its parameters:

- theoretical creep coefficient  $\varphi_o = 2$ ;
- coefficient  $\beta_H = 657.82$ .

To save the data press button **OK**.



In dialog window **Define standard section** press the button **Reinforcement parameters**. Set type of reinforcement *Point reinforcement* and enter coordinates and areas of reinforcement layers. Select type of cross-section division – *Division into elementary strips* and their number (5–10) and press the button **OK**.



Stiffness types with non-linear parameters will be marked with star symbol (\*) near their number. Assign created stiffness type to all elements in the model.

#### 6. Loading assignment.

Set 4 load cases on the beam in obedience to the variant.

#### 7. Non-linear loads assignment.

On the *Analysis* ribbon press the  *Step-type Method* button. Create two load histories – dead weight,  $q_1$ ,  $q_2$  and dead weight,  $q_1$ ,  $q_3$ . To do this in dialog window **Model nonlinear load cases of the structure** press  *Add* button to create new load history. Add parameters for the first load in the history – static load case number, calculation method – *(1) Step*, minimum number of iterations – 300, number of calculation steps – 5. For the second and the third load in history press  *Add* button and set same parameters except number of calculation steps – use 30. In the history list on the right side of the dialog window select load history <<1>> and set duration of creep period in days for calculation in the *Creep* field – 365 730.

To create the second load history select history  $\langle\langle I \rangle\rangle$  in the list and press  *Add* button. Add 3 load cases to this history with the same parameters as for load history  $\langle\langle I \rangle\rangle$ . Press  *OK* button to save data.

8. Provide problem calculation.

9. Results analysing.

On the *Results* ribbon display  $Q_z$ ,  $M_y$  diagrams for a beam. On the *Advanced results* ribbon press button  *Cracks in Bars* and display depth and width of cracks in concrete elements. To evaluate the influence of creep change the number of load period on the bottom toolbar.

### 3. Control questions.

1. Properties of physically nonlinear materials.
2. Concrete creep.
3. Parameters of physical non-linearity and their assignment in LIRA-SAPR.
4. Main laws of material deformation.
5. Assignment of reinforcement for concrete elements. Physical non-linearity of steel bars.
6. Modelling of non-linear loads. Load history.
7. Step-type procedure of non-linear problems solving.
8. Material state analysis after non-linear calculation.

## Laboratory work № 18. Calculation of reinforced concrete frame in a physically nonlinear formulation

**Aim of work:** familiarize with methods of control of the step processor of the LIRA-SAPR; perform modelling of a reinforced concrete frame in a physically nonlinear statement.

### 1. Task.



Using results of laboratory work № 2 perform a calculation of a reinforced concrete frame in a physically nonlinear statement.

### 2. Task processing.

1. New problem creation.

Open the file with the results of laboratory № 2 and save it as a new file with «LW18» name.

2. Changing type of finite elements.

Select all elements of the model and press the button  *Change FE Type* on the *Advanced edit options* ribbon. Select *FE type 210 – physically nonlinear arbitrary 3D bar* from the list press  *Apply* button.

### 3. Stiffness assignment.

Press the button  *Material Properties*. In the **Stiffness and Materials** dialog window select the existing stiffness type for beams and press the button **Edit**. Set checkbox *Nonlinear parameters* and press button **Material parameters**.

In the dialog window **Nonlinear stress-strain diagrams for materials** select diagram type *25 – exponential* and assign concrete class and type. Set checkbox *Account of reinforcement*. Go to tab *Reinforcement*, select type of diagram *11 – exponential* and set the following parameters:

- modulus of rigidity  $E_0(-) = 2.1e8 \text{ kN/m}^2$ ;  $E_0(+) = 2.1e8 \text{ kN/m}^2$ ;
- yield stress  $\sigma(-) = -2.85e5 \text{ kN/m}^2$ ;  $\sigma(+) = 2.85e5 \text{ kN/m}^2$ .



To save the data press button **OK**.



In the dialog window **Define standard section** press the button **Reinforcement parameters**. Set type of reinforcement *Point reinforcement* and enter coordinates and areas of reinforcement layers according to results of laboratory work № 7. Select type of cross-section division – *Division into elementary strips* and their number (5–10) and press the button **OK**.

Stiffness types with non-linear parameters will be marked with a star symbol (\*) near their number. Assign created stiffness type to corresponding elements in the model.

Repeat this step for the second stiffness type used for columns.

### 4. Non-linear loads assignment.

On the *Analysis* ribbon press the  *Step-type Method* button. In the dialog window **Model nonlinear load cases of the structure** press  *Add* button to create new load history. Add parameters for the first load in the history – static load case number, calculation method – *(1) Step*, a minimum number of iterations – 300, number of calculation steps – 7 and enter step values with space delimiter – *0.3 0.2 0.1 0.1 0.1 0.1 0.1*, set print option *Displacements and forces after every step*.

For the second and third steps in the history, press the  *Add* button and set the same parameters except for the number of calculation steps – use 8 equal steps. Press  *OK* button to save data.

### 5. Provide problem calculation.

### 6. Results analysis.

Display **N**, **Q<sub>z</sub>**, **M<sub>x</sub>** diagrams for model elements. Press button  *Information about Nodes and Elements*, click on the beam and display detailed data for this element – set checkbox *Diagrams*, after that set checkbox *Cracks*.



On the *Advanced results* ribbon press button  *Cracks in Bars* and display depth and width of cracks in concrete elements.

### **3. Control questions.**

1. Physically nonlinear finite elements.
2. Parameters of physical non-linearity and their assignment in LIRA-SAPR.
3. Main laws of material deformation.
4. Assignment of reinforcement for concrete elements. Physical non-linearity of steel bars.
5. Modelling of non-linear loads.
6. Step-type procedure of non-linear problem solving.
7. Control of step procedure solver in LIRA-SAPR.
8. Material state analysis after non-linear calculation.

## Recommended books

### Basic

1. Whiteley, J. Finite Element Methods: A Practical Guide / Jonathan Whiteley. – Springer, 2017. – 232 p.
2. Concepts and Applications of Finite Element Analysis [4<sup>th</sup> ed.] / Robert Cook, David Malkus, Michael Plesha, Robert Witt. – John Wiley & Sons Inc., 2012. – 719 p.
3. Finite Element Method with Applications in Engineering / Y. M. Desai, T. I. Eldho, A. H. Shah. – Pearson Education, 2011. – 492 p.
4. Larson, M. The Finite Element Method: Theory, Implementation, and Applications / Mats G. Larson, Fredrik Bengzon. – Springer Science & Business Media, 2013. – 395 p.

### Additional

1. Ragab, S. Introduction to Finite Element Analysis for Engineers / Saad A. Ragab, Hassan E. Fayed. – CRC Press, 2018. – 552 p.
2. Engineering Computation of Structures: The Finite Element Method / Maria Augusta Neto, Ana Amaro, Luis Roseiro, José Cirne [et al.]. – Springer, 2015. – 314 p.
3. Practical Finite Element Analysis / Nitin Gokhale, Sanjay Deshpande, Sanjeev Bedekar. – Finite to Infinite, 2008. – 446 p.

### Informational resources

1. E-course «Software for Engineering Design», ID 2433 – <https://dl.tntu.edu.ua>
2. LIRA-SAPR learning videos – <https://www.youtube.com/user/LiraLand>



Навчально-методична література

Сорочак А.П.

**Методичні вказівки  
до виконання лабораторних робіт  
з курсу «Програмне забезпечення інженерних  
розрахунків»**

для студентів спеціальності  
192 «Будівництво та цивільна інженерія»  
всіх форм навчання

Формат 60x90/16. Обл. вид. арк. 2,25. Тираж 10 пр. Зам. № 3569

Видавництво Тернопільського національного  
технічного університету імені Івана Пулюя.  
46001, м. Тернопіль, вул. Руська, 56.  
Свідоцтво суб'єкта видавничої справи ДК № 4226 від 08.12.11.