



UDC 539.434

INVESTIGATION OF THE INFLUENCE OF BOUNDARY CONDITIONS AND DEGRADATION FACTOR OF THE SURFACE LAYER ON THE GTE STRUCTURAL ELEMENTS STRESS-STRAIN STATE

**Leonid Kravchuk; Evgenii Zadvornyi; Kostiantyn Buiskykh;
Mykola Feofentov; Svitlana Kyselevska**

G.S. Pisarenko Institute for Problems of Strength of the NAS of Ukraine

Summary. The influence of the boundary conditions of the nonstationary thermal cyclic loading and degradation of the material surface layers on the stress-strain state of the material of the wedge-shaped specimens, which model the gas-turbine engine blade edge, is shown using the methods of physical and mathematical modeling with the presence of crack-type defects. The necessity of the investigation of structural changes and properties of the material, thermal and thermal-deformed state of the material is demonstrated to determine the possibilities of safe extension of the given lifetime of the equipment and assurance of efficiency as well as reliability of energy systems.

Key words: heat-resistant alloy, degraded surface layer, thermal fatigue crack, thermal stress state, gas-turbine engine.

Received 02.11.2017

Statement of the problem. The development of modern aircraft and power engineering industries are considerably concerned with the demand to solve the problem of power system reliability and efficiency and particularly gas-turbine engine (GTE) as their integrated component. At the same time the actual state of existing power complexes needs a reasonable and safe extension of the given lifetime while the basic units of the most power plants are on the boundary of the given lifetime or have already exhausted it. Therefore, the problem of the development and improvement of methods for determining the real stress-strain state of the structural elements, the possibilities of evaluating its dependence on operating conditions and material degradation factor, the development of scientifically based methods of analysis of material damage kinetics during operation, testing and system implementation of repair technologies taking into account these factors for lifetime extension remain particularly important.

Analysis of the available investigations. The results of the researches concerning the GTE operating conditions and the influence of various factors on stress-strain state (SSS) of their parts [1, 2] are widely presented in literature. Turbine blades are under the most difficult conditions as they undergo substantial influence of thermal stresses caused by the occurrence of significant temperature gradients and stresses produced by abrupt changes of operating modes.

The investigation of the material surface layer damage in the most loaded elements of the gas turbine engines under thermocyclic loading [3 – 5] demonstrated significant changes in the material structure and elemental composition of this degraded layer on the stage before thermal fatigue cracks occurrence as well as in the mouth and tip of the cracks in the process of their distribution.

The intensity of these processes proved the demand of their consideration while calculating the thermal and stress-strain state (TSSS) of high-temperature elements of gas-

turbine engine structures. TSSS estimate is based on experimental data of the thermal state kinetics of GTE blades samples and metallographic investigations of the material structural state kinetics providing the possibility of large-scale calculations taking into account the significance of the effect of degraded layers and formed thermal fatigue cracks.

The objective of the work. The main objective of the investigation which results are given below is to determine the influence of nonstationary thermal cyclic loading particularly the boundary conditions on the stress-strain state of GTE parts using the methods of physical and mathematical modeling and the development of scientifically based methods for analysis of material damage kinetics during operation taking into account TSSS and degraded layer interaction.

Statement of the problem and results of the investigation. As the initial data, the results of thermofatigue tests on wedge-shaped specimens, which model the state of the GTE blade edge material under actual operating conditions were used. The nature of the material load in such tests in contrast to other types of load has a certain characteristics having the TSSS spatial-temporal heterogeneity as well as a number of concomitant factors that affect the material damage during operation. Experimental investigations on the wedge-shaped specimens (Fig. 1) were carried out on gas-dynamic stands of *G.S.Pisarenko Institute for Problems of Strength of the NAS of Ukraine* allowing to investigate the material behavior in fuel combustion products providing the possibility of applying additional mechanical load and introduction of chemical compounds into the stream. During the tests, the processes of material damage and kinetics of formation and development of thermal fatigue cracks were investigated (Fig. 2). The results of thermometry of research objects during bench tests under the fixed modes of thermocyclic loading were the basis for the numerical analysis of TSSS material in the cycle. During the research process the required values of temperature and SSS of the edge material were achieved by choosing the geometric parameters of the sample: span angle – φ , the edge rounding radius – r , the chord length – L , the specimen height – H .

The solution of the problem of determining of the investigated specimen TSSS, modeling of these factors effect on the specimens SSS was carried out in spatial formulation. The thermal state of the wedge-shaped specimen material was determined by solving the nonlinear spatial problem of non-stationary heat conductivity under the mixed boundary conditions of heat exchange taking into account the spatial and temporal heterogeneity of the thermal processes and material damage processes characteristic for GTE blades.

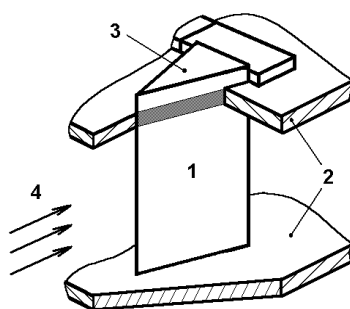

Figure 1. Specimen in the camera:
1 – specimen, 2 – camera walls, 3 – specimen end surface, 4 –high-temperature gas flow

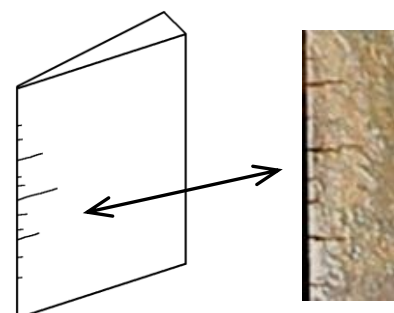

Figure 2. Cracks at the specimen edge

The use of three-dimensional modeling is an essential condition to get the valid data for the analysis of SSS kinetics of material damage on the edge along the specimen height. Accepted DSTU [6] along with the calculation in two-dimensional formulation allows us to investigate the state of the material in the middle of the sample. In spatial formulation it is

possible to investigate the influence of the unsteady in height SSS specimen on the origin and development of thermal fatigue cracks at different load levels, the role of their sizes, as concentrators, in the process of redistribution of TSSS. Spatial approaches allow (according to the TSSS parameters) to study quantitatively the effect of material surface layers degradation both in the crack area zone and outside it.

The applicability of the nonstationary thermal conductivity of the third kind boundary conditions is determined by the need to assess the heat-resistant coatings impact, the structural elements material degradation and its damage to the SSS, where the possibilities of the experiment are limited as well as to carry out calculations of different size-type specimens according to the results of one size-type specimens tests.

The determination of the third kind boundary conditions was carried out according to the results of solving the direct and inverse heat conduction problem under the first kind boundary conditions and by solving the problem of the investigated model flow by the gas flow of the given parameters using the methods of numerical simulation (Figs 3, 4). To determine the third kind boundary conditions by solving the flow problem, the information about the changes in gas stream temperature and the pressure time at the entrance to the test chamber are recorded during the experiment. These are the initial data for the determination of the heat-physical properties of the gas and its gas-dynamic characteristics (Fig.5). The control of the results was carried out by comparing the temperature distribution along the specimen surface obtained by calculation according to the specified third kind boundary conditions (Fig. 6) and to the results of the thermometry of the investigated specimens. The coincidence of the calculated results obtained by the first and second method of determining the boundary conditions in comparison with the experimental data shows the accuracy of the chosen calculation model and indicates the results reliability.

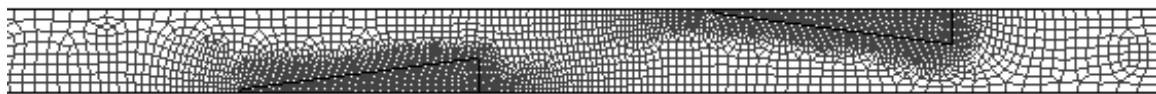

Figure 3. Finite element mesh in the gas flow dynamic state modeling

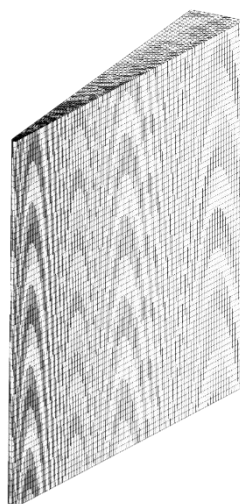

Figure 4. Three-dimensional finite element model of the specimen

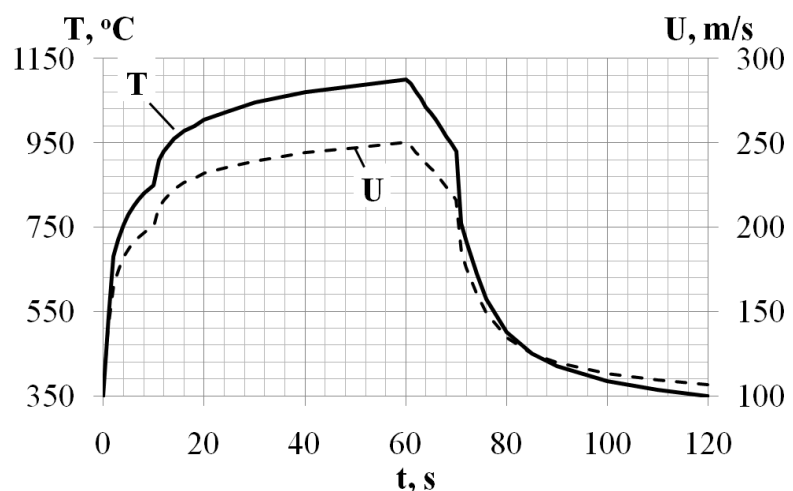

Figure 5. Boundary conditions for the gas-dynamic calculation:
T – gas flow temperature, U – velocity

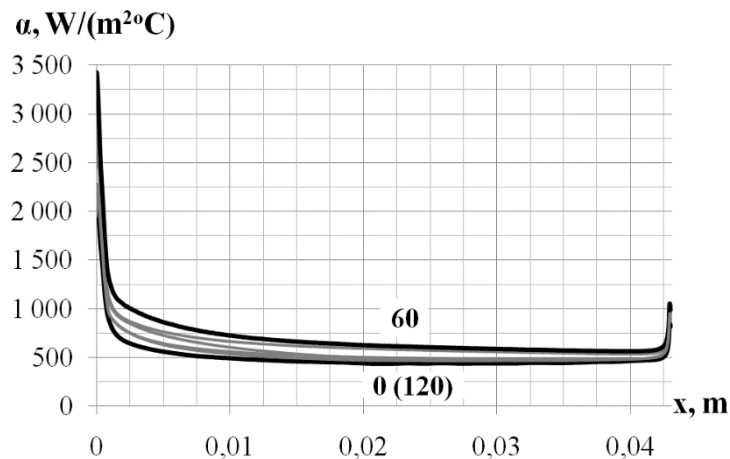

Figure 6. Distribution of the heat-exchange coefficients over the surface of the wedge-shaped model at various time instants

One of the factors that should be taken into account while calculating the investigated specimens especially analyzing the SSS change on the material damage along the specimen height on the margin area is the contact of the specimens with the investigated chamber walls (Fig.1. p.2). So in the contact area with the camera the conditions of heat exchange between the camera and the specimen as well as the flow conditions in the wall area should be taken into account. In fig. 7 the obtained results of stress changes on the wedge-shaped specimen height along the edge with span angle 15° , chord length 43 mm, height 80 mm in the direction from the median plane in a load cycle with a flow temperature from 350 to 1150 $^\circ\text{C}$ are shown. The given results with the considered features of heat exchange near the camera walls and without these features correspond to the time moments when maximum compressive stresses in the half-cyclic heating and the maximum tensile stresses in the half-cycle cooling occur. It can be seen from the obtained results that the significant difference in the stress level occurs even at the distance of 20-25 mm from the contact area with the camera and is more evident in specimens without a heat-protective coating. The results shown in Fig. 8, reflect the stress change nature along the sample at height of 30 mm from the median plane.

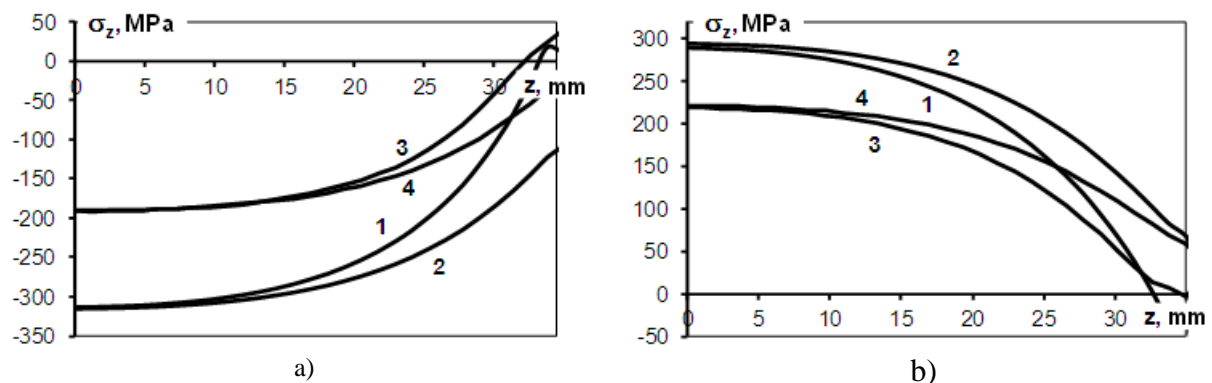

Figure 7. Change of the maximum compressive (a) and tensile (b) stresses in the cycle throughout the height of the specimen along the edge without coating (1, 2) and in the base material on the specimens with coating (3, 4): 1, 3 – on the specimens with the considered features of heat-exchange near the camera walls; 2,4 – without the camera walls effect

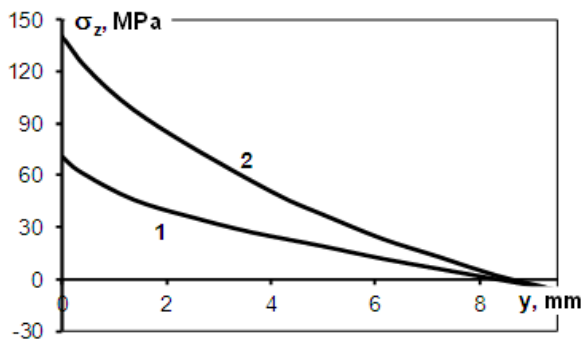

Figure 8. Variation of the maximum tensile stresses along the specimen chord at the height of 30 mm from the median plane:

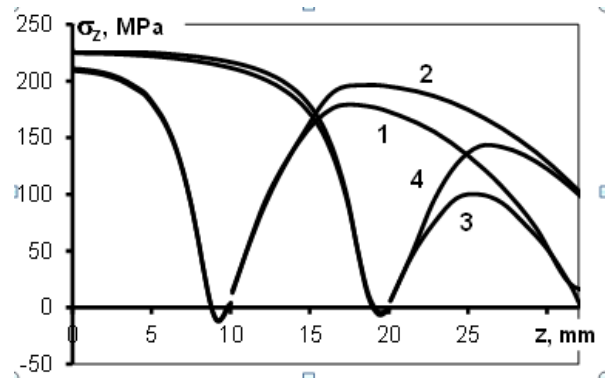

Figure 9. Variation of the maximum tensile stresses along the edge of the specimen with a crack at the height of 10 mm (1, 2) and of the specimen with a crack at the height of 20 mm (3, 4):

1, 3 – on the specimens with the considered features of heat-exchange near the camera walls; 2,4 – without the camera walls effect

According to the results of experimental investigations [7], three characteristic areas with different cracks development rates are distinguished on the wedge-shaped specimens. Cracks with the highest growth rate occur in the first zone with the width of approximately 20 mm in the middle part of the specimen due to higher levels of stresses. The second and third zones are characterized by lower cracks growth rates and located at an altitude where the error considering the contact with the camera results in significant errors in the results interpretation. So Fig. 9 shows how the cracks affect the tensile state of the specimen edge and the redistribution of stresses taking into account heat transfer characteristics near the camera walls and without these features being taken into account.

The peculiarity of the investigations of the damage stage of the structural element material characterized by thermal fatigue cracks availability is in the fact that cracks occurred in different areas of the wedge-shaped specimens different in the part thermo-stressed state and therefore different in the degraded layer damage degrees and cracks kinetics depending on the cycles amount (operating life) after their occurrence are analyzed in the given paper.

The degree of change in the material properties of the GTE structural element are estimated according to the results of the microhardness measurements near and far from the thermal fatigue crack. Data of the microhardness measurements in the area of thermal fatigue cracks in the specimen made from the ChS70VI alloy after 5800 of thermal modification cycles are given below. Crack 1 with the length 7 mm occurs after 1500 cycles in the most specimen thermostressed central area, and crack 2 with the length 3.8 mm occurs after 1750 cycles – in the peripheral and less thermostressed area. The scheme of thermal fatigue cracks location on the wedge-shaped specimen and their kinetics are shown in Fig. 10.

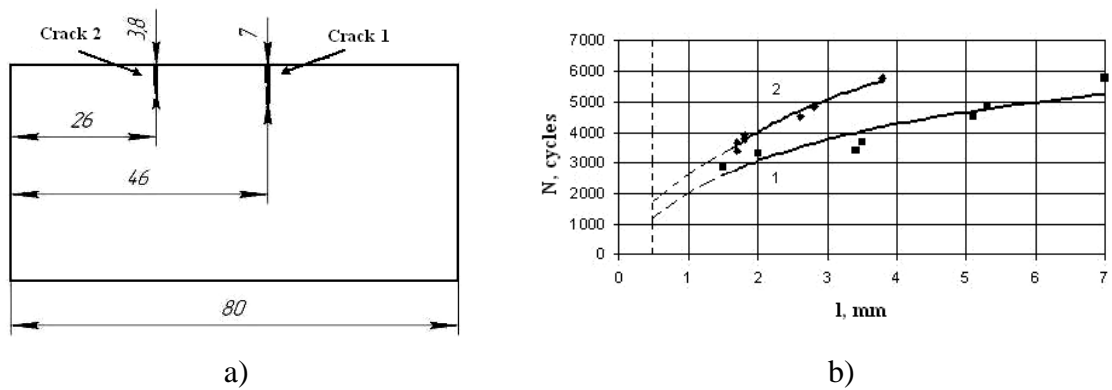

Figure 10. Scheme of thermal fatigue cracks location on the wedge-shaped specimen (a) of ChS70VI alloy and their kinetics (b)

Indentation of microslices is carried out along the lines perpendicular to the crack in the direction from the alloy to the crack. Each of the lines is at a different distance from the surface of the specimen. A similar method of indentation is used on each of the two cracks. The indentation scheme for each of the two cracks, as well as the value of microhardness in the mouth (a) and the tip (b) of the two cracks (1 and 2) are shown in Fig. 11.

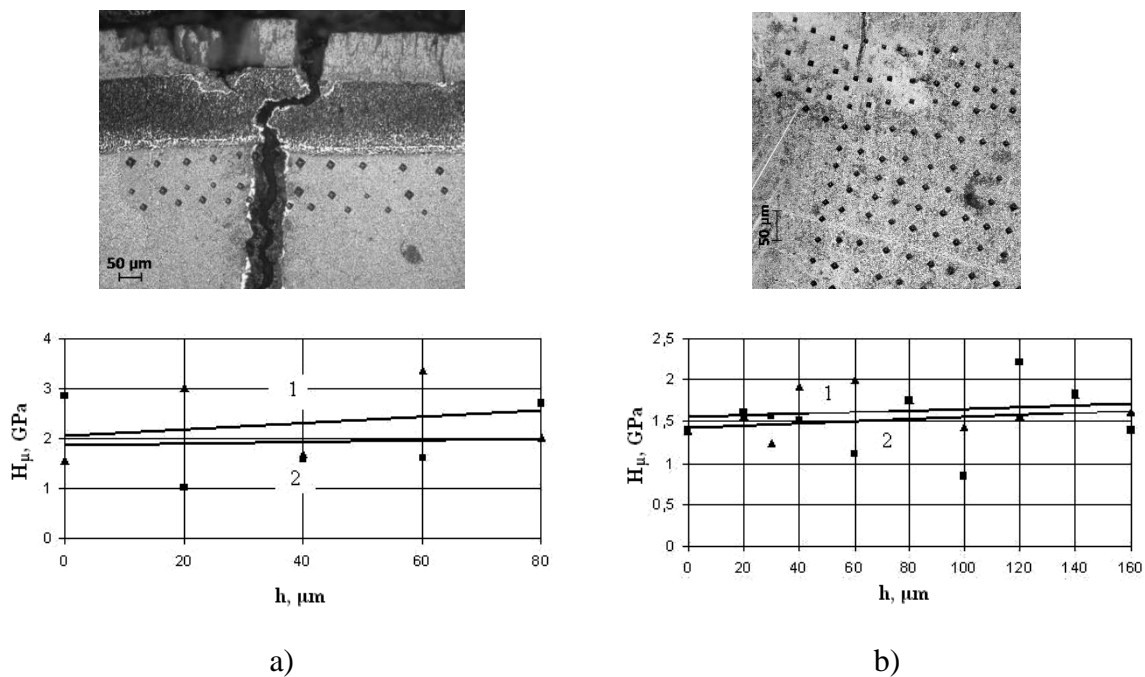

Figure 11. Scheme of indentation and microhardness at the mouth (a) and at the tip (b) of two cracks (1 i 2) on the wedge-shaped specimen of ChS70VI alloy

Analysis of data shown in Fig. 11 on microhardness indicates the following: the averaged values of the microhardness for crack 1 are higher compared to the crack 2. This is observed for both the mouth and the tip. Decrease of microhardness with removal from the crack is characteristic of the mouth. At the crack tip the values of microhardness are lower than that of the mouth. The given data indicate that at the same load length more significant processes of the wedge-shaped specimen material damaging are observed in the crack 1 mouth compared to the crack 2 and they result from the effect of higher temperatures and thermal stresses peculiar to the central area of the structural element.

The results of the investigations of the material degradation degree on the specimen surface [8] show that the degraded layer depth after 2300 cycles of loading reaches 40-45 μm . In some cases, the degraded layer depth reaches 100 μm . Taking into account that the sample edge is the most loaded, calculations of the degraded layer effect on the change of the material SSS in comparison with the undamaged sample are carried out. Since the physico-mechanical properties of the layers of the degraded layer are not known, in order to calculate the wedge-shaped specimen with degraded surface layer, the averaged characteristics of homogeneous Ni oxide are used, and to calculate the layer depleted by the γ' phase, the properties of the alloy with the structure without γ' phases are applied. Fig. 12 shows that the degraded layer can substantially affect the stress levels in the main material. It should be taken into account that these results have estimation character and are carried out for undamaged specimen and specimens with the degraded layer having zero field of residual stresses corresponding to temperatures 350 and 1100 $^{\circ}\text{C}$. Calculations of real constructions should be probabilistic as material degradation usually occurs at different load temperatures.

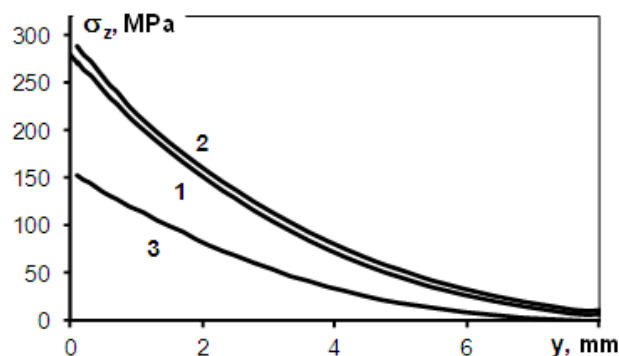

Figure 12. Variation of the maximum tensile stresses along the specimen chord:
1 – undamaged specimen, 2, 3 – specimen with the degraded layer of 100 μm on the material surface
(2 – zero residual stresses at $T = 350\text{ }^{\circ}\text{C}$, 3 – $T = 1100\text{ }^{\circ}\text{C}$)

Conclusions. It is determined that the influence of the boundary conditions and the degraded layer on the material SSS is very important and even minor changes or errors which take into account the conditions of the specimen heat exchange or the real structure elements, determine the contribution of the degraded surface layer to the general stressed state of the structural element can result in significant deviations from real SSS and consequently to the service life evaluation and design survivability as a whole.

The significant role of material surface degradation process in the areas of extreme temperatures and stresses for the structure elements lifetime decrease is shown. Therefore, the solution of the problems of the lifetime estimation of the GTE high-temperature structure elements is fundamental considering the interaction of the material degraded surface layer and the stress-strain state.

References

1. Tret'yachenko G.N., Kravchuk L.V., Kuriat R.I., et al., Thermal Fatigue of Materials under Conditions of Inhomogeneous Thermal Stressed State, Naukova Dumka, Kiev, 1985, 278 p. [in Russian].
2. Getsov L.B., Materials and Strength of the Components of Gas Turbines, Nedra, Moscow, 591 p. [in Russian].
3. Bensch M., Sato A., Warnken N., Affeldt E., Reed R.C., Glatzel U. Modelling of High Temperature Oxidation of Alumina-Forming Single-Crystal Nickel-Base Superalloys, Acta Materialia, Vol. 60, Is. 15, 2012, pp. 5468 – 5480.
4. Sato A., Chiu Y.-L., Reed R.C. Oxidation of nickel-based single-crystal superalloys for industrial gas turbine applications, Acta Materialia, Vol. 59, 2011, pp. 225 – 240.
5. Buiskykh K.P., Kiselevskaya S.G., Kravchuk L.V., Zadvornyi E.A., Feofentov N.N. Kinetics and Mechanisms of Degradation of the Surface Layers of Gas-Turbine Engine Structural Components Under

- Cyclic Thermal Loading During Initiation and Propagation of Thermal Fatigue Crack, Strength of Materials, Vol. 48, Is. 6, 2016, pp. 64 – 72.
6. DSTU 2367-94. Unified System of Protection against Corrosion and Aging. Refractory Metals, Alloys, and Coatings. A Method for Testing for High-Temperature Corrosion and Thermal Fatigue in a Flow of the Combustion Products of Fuel [in Ukraine], Kiev, Valid since February 25, 1994.
 7. Kravchuk L.V., Kuriat R.I., Buiskikh K.P., Zadvornyi E.A., Kiselevskaya S.G. Study of Damage Kinetics of Heat-Resistant Alloys Subjected to Thermocyclic Loading in a Gas Flow, Strength of Materials, Vol. 382 (38), Is. 4, 2006, pp. 386 – 391.
 8. Kravchuk L.V., Kuriat R.I., Buiskikh K.P., Kiselevskaya S.G. Surface Layers' Degradation of Heat-Resistant Alloys and Thermal Fatigue Damageability of Gas Turbine Engine Structural Components, Strength of Materials, Vol. 395 (40), Is. 5, 2008, pp. 552 – 559.

Список використаної літератури

1. Термическая усталость материалов в условиях неоднородного термонапряженного состояния [Текст] / [Третьяченко Г.Н., Кравчук Л.В., Курият Р.И. и др.]. – К.: Наук. думка, 1985. – 278 с.
2. Гецов, Л.Б. Материалы и прочность деталей газовых турбин [Текст] / Л.Б. Гецов. – М.: Недра, 1996. – 591 с.
3. Bensch, M. Modelling of High Temperature Oxidation of Alumina-Forming Single-Crystal Nickel-Base Superalloys [Text] / M. Bensch, A. Sato, N. Warnken, E. Affeldt, R.C. Reed, U. Glatzel // Acta Materialia. – 2012. – Vol. 60. – Is. 15. – P. 5468 – 5480.
4. Sato A. Oxidation of nickel-based single-crystal superalloys for industrial gas turbine applications / A. Sato, Y.-L. Chiu, R.C. Reed // Acta Materialia. – 2011. – Vol. 59. – P. 225-240.
5. Buiskikh, K.P. Kinetics and Mechanisms of Degradation of the Surface Layers of Gas-Turbine Engine Structural Components Under Cyclic Thermal Loading During Initiation and Propagation of Thermal Fatigue Cracks [Text] / K.P. Buiskikh, S.G. Kiselevskaya, L.V. Kravchuk, E.A. Zadvornyi, N.N. Feofentov // Strength of Materials. – 2016. – Vol. 48. – Is. 6. – P. 64 – 72.
6. Єдина система захисту від корозії та старіння. Метали, сплави, покриття жаростійкі. Метод випробувань на високотемпературну корозію та термовтому в потоці продуктів горіння палива: ДСТУ 2367-94. – [Чинний від 1994-01-01]. – Наказ № 94 від 25.02.94. – 9 с. – (Національний стандарт України).
7. Kravchuk, L.V. Study of Damage Kinetics of Heat-Resistant Alloys Subjected to Thermocyclic Loading in a Gas Flow [Text] / L.V. Kravchuk, R.I. Kuriat, K.P. Buiskikh, E.A. Zadvornyi, S.G. Kiselevskaya // Strength of Materials. – 2006. – Vol. 382 (38). – Is. 4. – P. 386 – 391.
8. Kravchuk, L.V. Surface Layers' Degradation of Heat-Resistant Alloys and Thermal Fatigue Damageability of Gas Turbine Engine Structural Components [Text] / L.V. Kravchuk, R.I. Kuriat, K.P. Buiskikh, S.G. Kiselevskaya // Strength of Materials. – 2008. – Vol. 395 (40). – Is. 5. – P. 552 – 559.

УДК 539.434

ДОСЛІДЖЕННЯ ВПЛИВУ ГРАНИЧНИХ УМОВ І СТУПЕНЯ ДЕГРАДАЦІЇ ПОВЕРХНЕВОГО ШАРУ НА НАПРУЖЕНО- ДЕФОРМОВАНИЙ СТАН ЕЛЕМЕНТІВ КОНСТРУКЦІЙ ГТД

**Леонід Кравчук; Євгеній Задворний; Костянтин Буйських;
Микола Феофентов; Світлана Киселевська**

*Інститут проблем міцності імені Г.С. Писаренка НАН України,
Київ, Україна*

Резюме. Показано вплив граничних умов нестационарного термоциклічного навантаження та деградації поверхневих шарів матеріалу на напружено-деформований стан матеріалу клиновидних зразків, що моделюють кромку лопаток газотурбінних двигунів, з використанням методів фізичного і математичного моделювання за наявності дефектів типу тріщин. Вказано на необхідність дослідження процесів змін структури і властивостей матеріалу, теплового та напружено-деформованого стану матеріалу для визначення можливості безпечного подовження встановленого ресурсу існуючого обладнання, забезпечення економічності та надійності нових енергетичних систем.

Ключові слова: жароміцний сплав, деградований поверхневий шар, термовтомна тріщина, термонапружений стан, газотурбінний двигун.

Отримано 02.11.2017